

# TECHNICAL RESOURCE DOCUMENT

## EXTRACTION AND BENEFICIATION OF ORES AND MINERALS

### VOLUME 4

# COPPER

August 1994

U.S. Environmental Protection Agency  
Office of Solid Waste  
Special Waste Branch  
401 M Street, SW  
Washington, DC 20460



## **DISCLAIMER AND ACKNOWLEDGEMENTS**

This document was prepared by the U.S. Environmental Protection Agency (EPA). The mention of company or product names is not to be considered an endorsement by the U.S. Government or by the EPA.

This Technical Resource Document consists of four sections. The first is EPA's Profile of the copper industry; the remaining sections are Reports from several site visits conducted by EPA. The Profile Section was distributed for review to the U.S. Department of the Interior's (DOI's) Bureau of Mines and Bureau of Land Management; the States of Arizona, New Mexico, and Utah; the American Mining Congress (AMC), and environmental organizations. Summaries of the comments and EPA's responses are presented as Appendix 1-A to the Profile Section. The Site Visit Reports were reviewed by individual company, State, and Federal representatives who participated in the site visit. Comments and EPA responses are included as appendices to the specific Site Visit Section. EPA is grateful to all individuals who took the time to review sections of this Technical Resource Document.

The use of the terms "extraction," "beneficiation," and "mineral processing" in the Profile section of this document is not intended to classify any waste streams for the purposes of regulatory interpretation or application. Rather, these terms are used in the context of common industry terminology.

**TABLE OF CONTENTS**

	<u>Page</u>
DISCLAIMER AND ACKNOWLEDGEMENTS .....	i
<b>1.0 MINING INDUSTRY PROFILE: COPPER</b> .....	<b>1-1</b>
1.1 INTRODUCTION.....	1-1
1.2 ECONOMIC CHARACTERIZATION OF THE INDUSTRY .....	1-3
1.3 ORE CHARACTERIZATION .....	1-7
1.3.1 Porphyry Copper and Associated Deposits .....	1-7
1.3.2 Sedimentary and Metasedimentary Deposits.....	1-8
1.3.3 Volcanogenic Massive Sulfide Deposits .....	1-8
1.3.4 Veins and Replacement Deposits .....	1-8
1.3.5 Ultrabasic and Carbonatite Deposits .....	1-8
1.3.6 Mineral Assemblages.....	1-8
1.4 COPPER EXTRACTION AND BENEFICIATION PRACTICES .....	1-10
1.4.1 Extraction Operations .....	1-10
1.4.1.1 Typical Mining Operations.....	1-10
1.4.1.2 Surface Mining Methods .....	1-10
1.4.1.3 Underground Mining Methods .....	1-11
1.4.2 Beneficiation Operations .....	1-16
1.4.2.1 Conventional Milling/Flotation .....	1-16
1.4.2.2 Leach Operations ( <i>In Situ</i> , Dump, Heap, and Vat).....	1-28
1.5 WASTES AND OTHER MATERIALS ASSOCIATED WITH COPPER EXTRACTION AND BENEFICIATION.....	1-49
1.5.1 Extraction and Beneficiation Wastes and Materials.....	1-49
1.5.1.1 RCRA Wastes.....	1-51
1.5.1.2 Materials .....	1-52
1.5.2 Waste and Materials Management.....	1-55
1.5.2.1 RCRA Units.....	1-55
1.5.2.2 Non-RCRA Units.....	1-58
1.6 ENVIRONMENTAL EFFECTS.....	1-61
1.6.1 Potential Sources of Contamination .....	1-61
1.6.1.1 Mine Dewatering .....	1-61
1.6.1.2 Releases from Active Leach Units .....	1-61
1.6.1.3 Releases from Leach Units During and After Closure.....	1-62
1.6.1.4 Releases from Tailings Impoundments .....	1-63
1.6.1.5 Acid Drainage.....	1-63
1.6.1.6 Beneficiation Reagents.....	1-65
1.6.2 Factors Affecting the Potential for Contamination.....	1-65
1.6.3 Affected Media .....	1-66
1.6.3.1 Ground Water/Surface Water.....	1-66
1.6.3.2 Soil.....	1-66
1.6.3.3 Air.....	1-67
1.6.4 Damage Cases.....	1-67
1.6.4.1 National Priorities List .....	1-67
1.6.4.2 304(l) Sites.....	1-67
1.7 CURRENT REGULATORY AND STATUTORY FRAMEWORK .....	1-69
1.7.1 Environmental Protection Agency Regulations.....	1-69

1.7.1.1	Resource Conservation and Recovery Act .....	1-69
1.7.1.2	Clean Water Act .....	1-71
1.7.1.3	Clean Air Act.....	1-73
1.7.2	Department of the Interior .....	1-74
1.7.2.1	Bureau of Land Management .....	1-74
1.7.2.2	National Park Service and Fish and Wildlife Service .....	1-76
1.7.3	Department of Agriculture.....	1-77
1.7.3.1	Forest Service .....	1-77
1.7.4	Army Corps of Engineers .....	1-78
1.7.5	State Programs .....	1-78
1.7.5.1	Arizona .....	1-78
1.8	REFERENCES .....	1-83

**2.0 MINE SITE VISIT: ASARCO/TROY MINE .....** 2-1

2.1	INTRODUCTION .....	2-1
2.1.1	Background .....	2-1
2.1.2	General Facility Description.....	2-2
2.1.3	Environmental Setting .....	2-5
2.1.3.1	Surface Water .....	2-5
2.1.3.2	Geology .....	2-6
2.1.3.3	Hydrogeology .....	2-6
2.2	FACILITY OPERATIONS .....	2-9
2.2.1	Mining Operations .....	2-9
2.2.2	Milling Operations.....	2-11
2.3	WASTE MANAGEMENT .....	2-14
2.3.1	Types of Waste .....	2-14
2.3.2	Solid Waste Management Units .....	2-14
2.3.2.1	Tailings Thickener.....	2-14
2.3.2.2	Tailings Pipeline.....	2-15
2.3.2.3	Tailings Impoundment.....	2-15
2.3.2.4	Waste Rock.....	2-20
2.3.2.5	Waste Oil Storage Tanks .....	2-20
2.3.2.6	Burn Pit.....	2-20
2.3.3	Waste Water Management Units .....	2-20
2.3.3.1	Mine Water.....	2-20
2.3.3.2	Sanitary Sewage .....	2-21
2.3.3.3	Assay Laboratory Wastes .....	2-21
2.3.4	Hazardous Waste Management Unit .....	2-21
2.3.4.1	Waste Solvent Tanks .....	2-21
2.4	MONITORING .....	2-22
2.4.1	Surface Water .....	2-22
2.4.2	Ground Water .....	2-24
2.4.3	Air .....	2-24
2.5	REGULATORY REQUIREMENTS AND COMPLIANCE.....	2-25
2.5.1	Operating Permit.....	2-25
2.5.2	Solid Waste.....	2-26
2.5.3	Surface Water .....	2-26
2.5.4	Ground Water .....	2-26

---

2.5.5	Air .....	2-26
2.5.6	Hazardous Waste .....	2-27
2.6	REFERENCES .....	2-28
<b>3.0</b>	<b>MINE SITE VISIT: SAN MANUEL FACILITY MAGMA COPPER COMPANY .....</b>	<b>3-1</b>
3.1	INTRODUCTION .....	3-1
3.1.1	Background .....	3-1
3.1.2	General Description .....	3-2
3.1.3	Environmental Setting .....	3-4
3.1.3.1	Geology .....	3-5
3.1.3.2	Hydrology .....	3-7
3.2	FACILITY OPERATIONS .....	3-12
3.2.1	Oxide Ore .....	3-12
3.2.1.1	Open Pit Extract .....	3-12
3.2.1.2	Beneficiation of Oxide Ores .....	3-15
3.2.2	Sulfide Ore .....	3-24
3.2.2.1	Extraction .....	3-24
3.2.2.2	Beneficiation .....	3-25
3.2.2.3	Processing Operations .....	3-30
3.3	WASTE AND MATERIALS MANAGEMENT .....	3-35
3.3.1	Types of Wastes and Materials .....	3-35
3.3.2	Underground Workings, Open Pit, and <i>In situ</i> Leach Area .....	3-35
3.3.3	Waste Rock .....	3-37
3.3.4	Dump/Heap Leach and SX/EW Plant .....	3-37
3.3.4.1	Heap Leach .....	3-37
3.3.4.2	Solvent Extraction/Electrowinning Wastes .....	3-40
3.3.5	Tailings Impoundments .....	3-41
3.3.5.1	Tailings .....	3-41
3.3.5.2	Tailings Impoundment Construction and Reclamation .....	3-41
3.3.5.3	Tailings Reclamation .....	3-42
3.3.5.4	Co-mingling of Wastes in the Tailings Impoundments .....	3-43
3.3.6	Other Waste .....	3-43
3.3.6.1	Landfill .....	3-43
3.3.6.2	Sewage .....	3-44
3.3.7	Waste Minimization .....	3-44
3.4	REGULATORY REQUIREMENTS AND COMPLIANCE .....	3-46
3.4.1	Federal Permits .....	3-46
3.4.1.1	Clean Water Act .....	3-46
3.4.1.2	Resource Conservation and Recovery Act .....	3-48
3.4.2	State of Arizona Permits .....	3-48
3.4.2.1	Groundwater Quality Protection Permit (GWQPP) .....	3-48
3.4.2.2	Aquifer Protection Permit (APP) .....	3-49
3.4.2.3	Air Permits .....	3-51
3.5	REFERENCES .....	3-52
<b>4.0</b>	<b>MINE SITE VISIT: COOPER RANGE COMPANY WHITE PINE MINE .....</b>	<b>4-1</b>
4.1	INTRODUCTION .....	4-1

---

4.1.1	Background.....	4-1
4.1.2	General Facility Description.....	4-2
4.1.3	Environmental Setting .....	4-3
	4.1.3.1 Geology .....	4-4
	4.1.3.2 Hydrology.....	4-7
4.2	FACILITY OPERATIONS .....	4-10
4.2.1	Mining Operations .....	4-10
4.2.2	Beneficiation Operations .....	4-12
	4.2.2.1 Crushing and Grinding .....	4-12
	4.2.2.2 Flotation.....	4-13
	4.2.2.3 Concentrate Thickening.....	4-15
	4.2.2.4 Filtering and Drying .....	4-15
4.2.3	Smelting and Refining .....	4-16
4.2.4	Other Areas .....	4-17
	4.2.4.1 Assay Laboratory.....	4-17
	4.2.4.2 Fuel Oil Storage Areas .....	4-17
	4.2.4.3 Power Plant.....	4-17
	4.2.4.4 Shops .....	4-17
	4.2.4.5 Underground Storage Tanks.....	4-17
	4.2.4.6 Warehouse .....	4-18
	4.2.4.7 Wastewater Treatment Systems .....	4-18
	4.2.4.8 Potable Water System.....	4-18
4.3	WASTE AND MATERIALS MANAGEMENT .....	4-20
4.3.1	Extraction and Beneficiation Wastes and Materials.....	4-20
	4.3.1.1 Tailings .....	4-20
	4.3.1.2 Mine Water.....	4-24
4.3.2	Smelter Slag and Reveratory Bricks .....	4-24
4.3.3	Site Runoff.....	4-25
4.3.4	Other Wastes and Materials.....	4-25
	4.3.4.1 Laboratory .....	4-25
	4.3.4.2 Sanitary Wastewater.....	4-25
	4.3.4.3 Power Plant Wastes .....	4-25
	4.3.4.4 Waste Oil .....	4-26
	4.3.4.5 Refuse .....	4-26
	4.3.4.6 Spent Solvents .....	4-26
	4.3.4.7 Batteries .....	4-27
	4.3.4.8 Scrap Tires.....	4-27
	4.3.4.9 Asbestos.....	4-27
	4.3.4.10 Polychlorinated Biphenyls (PCBs).....	4-28
4.4	REGULATORY REQUIREMENTS AND COMPLIANCE.....	4-29
4.4.1	Mining Regulatory Requirements.....	4-29
4.4.2	Surface Water Permits and Monitoring .....	4-29
	4.4.2.1 NPDES Permit.....	4-29
	4.4.2.2 Lake Superior Mixing Zone Study .....	4-31
	4.4.2.3 Environmental Assessment of the Effects of Chloride and TDS Discharge on Lake Superior .....	4-32
	4.4.2.4 Biomonitoring Testing.....	4-33
4.4.3	Ground Water Monitoring .....	4-33
4.4.4	Air Permits and Monitoring.....	4-34

4.5 BIBLIOGRAPHY AND REFERENCES .....4-36

**APPENDICES**

APPENDIX 1-A SUMMARY OF COMMENTS AND EPA RESPONSES ..... 1-92  
APPENDIX 1-B CASE STUDIES OF PUBLISHED INFORMATION ON MINE  
WASTE MANAGEMENT PRACTICES AT COPPER MINES ..... 1-95  
APPENDIX 1-C NPL SITE SUMMARIES RELATED TO COPPER MINING  
ACTIVITIES ..... 1-147  
APPENDIX 1-D 304(l) SITE SUMMARIES RELATED TO COPPER MINING  
ACTIVITIES ..... 1-154  
APPENDIX 1-E ACRONYM LIST ..... 1-156  
  
APPENDIX 2-A ASARCO COMMENTS ON DRAFT SITE VISIT REPORT ..... 2-30  
APPENDIX 2-B EPA RESPONSES TO ASARCO COMMENTS ON DRAFT  
SITE VISIT REPORT ..... 2-32  
  
APPENDIX 4-A COMMENTS SUBMITTED BY COPPER RANGE  
COMPANY ON DRAFT SITE VISIT REPORT ..... 4-37  
APPENDIX 4-B EPA RESPONSE TO COMMENTS SUBMITTED BY  
COPPER RANGE COMPANY ON DRAFT SITE VISIT  
REPORT..... 4-39

**LIST OF TABLES**

	<u>Page</u>
Table 1-1. Leading United States Copper Producers in 1991, by Output .....	1-4
Table 1-2. Inventory of Active Copper Solution Mining Operations in the United States (1988) .....	1-6
Table 1-3. Reagent Consumption at U.S. Copper Sulfide Concentrators in 1985 .....	1-25
Table 1-4. Characteristics of Copper Leaching Methods .....	1-29
Table 1-5. Background on Copper Leaching Methods .....	1-29
Table 1-6. Lixiviants and Recommended Construction Materials .....	1-41
Table 1-7. Effluent Limitation Guidelines for Copper Mines and Mills (40 CFR Part 440) .....	1-72
Table 1-8. Beneficiation Equipment by Plant .....	1-100
Table 1-9. Reagent Consumption in Flotation Process .....	1-100
Table 1-10. Summary Data Sheet for the Kennecott Copper Company - Bingham Canyon Mine Tailings Pond Analysis .....	1-102
Table 1-11. Reagent Quantities Used at the Sierrita Concentrator .....	1-117
Table 1-12. Reagents and Ore Used at Mission Mine .....	1-144
Table 3-1. San Manuel Production Wells .....	3-11
Table 3-2. Leach Solution Flow at San Manuel .....	3-20
Table 3-3. Waste Minimization at San Manuel .....	3-45
Table 3-4. Environmental Permits for the San Manuel Facility .....	3-47
Table 4-1. Purpose and 1992 Application Rates of Flotation Reagent Classes .....	4-15
Table 4-2. 1991 Annual Reagent Consumption and 1992 Application Rates at Copper Range Company's White Pine Mine .....	4-15
Table 4-3. Results of Sampling for Constituents in Potable Water and Applicable MCLs .....	4-19
Table 4-4. Results of Tailings Analyses (May 3 and 4, 1992) .....	4-20
Table 4-5. Monitoring Data for Outfall 001 (January - March 1992) .....	4-30
Table 4-6. Monitoring Data for Outfall 00A (January - March 1992) .....	4-31
Table 4-7. Monitoring Data for Outfall 00B (January - March 1992) .....	4-31
Table 4-8. Results of Copper Range Company Biomonitoring Testing (April - October 1991) .....	4-34
Table 4-9. 1991 Annual Arsenic Monitoring Results .....	4-35

**LIST OF FIGURES**

	<u>Page</u>
Figure 1-1. States of Open-Pit Mining .....	1-12
Figure 1-2. Cut-and-Fill and Room-and-Pillar Underground Mining Methods .....	1-14
Figure 1-3. Block-Caving Methods .....	1-15
Figure 1-4. Flowsheet for Sulfide Ore Beneficiation .....	1-17
Figure 1-5. Typical Crushers .....	1-18
Figure 1-6. Typical Milling Units .....	1-20
Figure 1-7. Classifiers .....	1-21
Figure 1-8. Types of Flotation Cells .....	1-23
Figure 1-9. Flotation .....	1-27
Figure 1-10. Hydrometallurgical Recovery of Copper .....	1-32



---

Figure 1-11.	<i>In Situ</i> Leaching Operations .....	1-33
Figure 1-12.	Leach Dump Operations .....	1-36
Figure 1-13.	Heap Leach Unit Design.....	1-39
Figure 1-14.	Typical Autoclave and Vat Leaching Circuit.....	1-43
Figure 1-15.	Typical Solvent Extraction/Electrowinning (SX/EW) Plant.....	1-46
Figure 1-16.	Schematic of Typical Copper Mining Extraction and Beneficiation Wastestreams .....	1-50
Figure 1-17.	Upstream, Downstream and Centerline Methods of Construction.....	1-56
Figure 1-18.	Location of Bingham Canyon Mine .....	1-97
Figure 1-19.	Existing Ray Mine Site Disturbed Areas.....	1-106
Figure 1-20.	Cyprus Sierrita Process Location Map .....	1-114
Figure 1-21.	Cyprus Sierrita Facility Map .....	1-115
Figure 1-22.	Locations of Bagdad Leach Dumps.....	1-124
Figure 1-23.	Locations of Cyprus Miami Mine and Smelter Waste Dumps.....	1-133
Figure 1-24.	Water and Wastewater Management at Inspiration Operations .....	1-137
Figure 1-25.	Reservoirs and Impoundments at Cyprus Miami Mine and Smelter Operations .....	1-140
Figure 1-26.	ASARCO Mission Complex Facility Map .....	1-143
Figure 2-1.	General Project Location Map.....	2-3
Figure 2-2.	Facility Location Map, ASARCO Troy Mine .....	2-4
Figure 2-3.	ASARCO Troy Flow Diagram .....	2-10
Figure 2-4.	Location Map: Sampling Stations Base: USGS 7.5' Quadrangles: Crowell Mountain and Spar Lake 1963 (PR 1923).....	2-17
Figure 2-5.	Detail of Toe Ponds in Relation to Lake Creek.....	2-18
Figure 2-6.	Sampling Locations (e.g., FC-1): ASARCO Troy Unit Macroinvertebrate Monitoring Program.....	2-23
Figure 3-1.	San Manuel Mine and Mill Facilities .....	3-3
Figure 3-2.	Structure of San Manuel-Kalamazoo Deposit.....	3-6
Figure 3-3.	San Manuel Tailings Impoundments and Water Supply Wells.....	3-10
Figure 3-4.	San Manuel Open Pit and Mine Site .....	3-13
Figure 3-5.	Mill Facility .....	3-14
Figure 3-6.	Heap Leach at San Manuel .....	3-17
Figure 3-7.	Solvent Extraction/Electrowinning .....	3-23
Figure 3-8.	Copper Flotation Circuit.....	3-27
Figure 3-9.	Molybdenite Plant Circuit .....	3-29
Figure 3-10.	Slag Reprocessing.....	3-31
Figure 3-11.	Smelter Circuit at San Manuel .....	3-32
Figure 3-12.	Waste Rock Piles .....	3-38
Figure 4-1.	Location of Copper Range Company's White Pine Mine.....	4-4
Figure 4-2.	Geologic Cross Section of White Pine Area .....	4-6
Figure 4-3.	Surface Water in the White Pine Area .....	4-8
Figure 4-4.	Map of White Pine Mine .....	4-11
Figure 4-5.	Flow Sheet of Flotation Circuit .....	4-14
Figure 4-6.	Map of Tailings System.....	4-22

---

## 1.0 MINING INDUSTRY PROFILE: COPPER

### 1.1 INTRODUCTION

This Industry Profile presents the results of U.S. Environmental Protection Agency (EPA) research into the domestic copper mining industry and is one of a series of profiles of major mining sectors. Additional profiles describe lode gold, placer gold, lead/zinc, iron, and several industrial mineral sectors, as presented in the current literature. EPA has prepared these profiles to enhance and update its understanding of the mining industry and to support mining program development by the states. EPA believes the profiles represent current environmental management practices as described in the literature.

Each profile addresses the extraction and beneficiation of ore. The scope of the Resource Conservation and Recovery Act (RCRA) as it applies to mining waste was amended in 1980 when Congress passed the Bevill Amendment, Section 3001(b)(3)(A). The Bevill Amendment states that "solid waste from extraction, beneficiation, and processing of ores and minerals" is excluded from the definition of hazardous waste under Subtitle C of RCRA (40 CFR 261.4(b)(7)). The exemption was conditional on EPA's completion of studies required by RCRA Sections 8002(f) and (p) on the environmental and health consequences of the disposal and use of these wastes. EPA submitted the initial results of these studies in the 1985 *Report to Congress: Wastes from the Extraction and Beneficiation of Metallic Ores, Phosphate Rock, Asbestos, Overburden From Uranium Mining, and Oil Shale* (U.S. EPA 1985a). In July 1986, EPA made a regulatory determination that regulation of extraction and beneficiation wastes under Subtitle C of RCRA was not appropriate (51 FR 24496; July 3, 1986). EPA concluded that Subtitle C controls were unwarranted and found that a wide variety of existing Federal and State programs already addressed many of the risks posed by extraction and beneficiation wastes. Instead of regulating extraction and beneficiation wastes as hazardous wastes under Subtitle C, EPA indicated that these wastes should be controlled under Subtitle D of RCRA.

EPA reported their initial findings on mineral processing wastes from the studies required by the Bevill Amendment in the 1990 *Report to Congress: Special Wastes From Mineral Processing* (U.S. EPA 1990a). This report covered 20 specific mineral processing wastes; 3 of the 20 involved copper processing wastes. In June 1991, EPA issued a regulatory determination (56 FR 27300) stating that regulation of these 20 mineral processing wastes as hazardous wastes under RCRA Subtitle C is inappropriate or infeasible. These 20 wastes, including slag from primary copper processing, calcium sulfate wastewater treatment plant sludge from primary copper processing, and slag tailings from primary copper processing, are subject to applicable state requirements. Any mineral processing wastes not specifically included in this list of 20 wastes no longer qualifies for the exclusion (54 FR 36592). Due to the timing of this decision and the limited numbers of copper industry wastes at issue, copper processing wastes are not addressed in this profile.

In addition to preparing profiles, EPA has undertaken a variety of activities to support State mining programs. These activities include visiting a number of mine sites; compiling data from State regulatory agencies on waste characteristics, releases, and environmental effects; preparing summaries of mining-related sites on the National Priorities List (NPL); and examining specific waste management practices and technologies. EPA has also conducted studies of State mining-related regulatory programs and their implementation.

The purpose of this profile is to provide additional information on the domestic copper mining industry. The report describes copper extraction and beneficiation operations with specific reference to the wastes

associated with these operations. The report is based on literature reviews and on comments received on earlier drafts. This report complements, but was developed independently of, other Agency activities, including those described above.

This profile briefly characterizes the economics of the industry and the geology of copper ores. Following this discussion is a review of copper extraction and beneficiation methods; this section provides the context for descriptions of wastes and materials managed by the industry, as well as a discussion of the potential environmental effects that may result from copper mining. Appendix 1-B of this profile presents case studies of extraction and beneficiation methods at nine large copper mines in the United States in 1990. The profile concludes with a description of the current regulatory programs that apply to the copper mining industry as implemented by EPA, Federal land management agencies, and the State of Arizona.

## **1.2 ECONOMIC CHARACTERIZATION OF THE INDUSTRY**

The physical properties of copper, including malleability and workability, corrosion resistance and durability, high electrical and thermal conductivity, and ability to alloy with other metals, have made it an important metal to a number of diverse industries. Copper was an historically important resource for the production of tools, utensils, vessels, weapons, and objects of art. According to the Bureau of Mines, in 1992, copper production was used for building construction (41 percent), electrical and electronic products (24 percent), industrial machinery and equipment (13 percent), transportation (12 percent), and consumer products (10 percent) (U.S. DOI, Bureau of Mines 1993a).

The United States is the second largest copper producer in the world. Next to Chile, the United States had the second largest reserves (45 million metric tons) and reserve base (90 million metric tons) of contained copper in 1992. Also, in 1992, United States' copper operations produced about 1.7 million metric tons. In 1991, 1.63 million metric tons were produced. The total value of copper produced in 1992 (\$4.1 billion) is slightly more than 1991's value (\$3.9 billion). Arizona led production in 1992, followed by New Mexico, Utah, Michigan, and Montana. In the same year, copper was also recovered from mines in seven other States (U.S. DOI, Bureau of Mines 1993a, 1993b).

In 1991, the top 25 copper producers in the United States generated more than 95 percent of the United States' domestic copper production. These producers are listed in Table 1-1. By the end of 1991, 8 primary and 5 secondary smelters, 10 electrolytic and 6 fire refineries, and 14 electrowinning plants were in operation in the United States (U.S. DOI, Bureau of Mines 1993b).

**Table 1-1. Leading United States Copper Producers in 1991, by Output**

<b>Rank</b>	<b>Mine</b>	<b>County and State</b>	<b>Operator</b>
1	Morenci/Metcalf	Greenlee, AZ	Phelps Dodge Corporation
2	Bingham Canyon	Salt Lake, UT	Kennecott, Utah Copper Corporation
3	San Manuel	Pinal, AZ	Magma Copper Company
4	Chino	Grant, NM	Phelps Dodge Corporation
5	Tyrone	Grant, NM	Phelps Dodge Corporation, Burro Chief Copper Company
6	Sierrita	Pima, AZ	Cyprus Sierrita Corporation
7	Ray Complex	Pinal, AZ	ASARCO Incorporated
8	Bagdad	Yavapai, AZ	Cyprus Bagdad Copper Company
9	Pinto Valley	Gila, AZ	Pinto Valley Copper Corporation
10	Mission Complex	Pima, AZ	ASARCO Incorporated
11	Inspiration	Gila, AZ	Cyprus Miami Mining Corporation
12	White Pine	Ontonagon, MI	Copper Range Company
13	Continental	Silver Bow, MT	Montana Resources, Inc.
14	Twin Buttes	Pima, AZ	Cyprus Sierrita Corporation
15	Troy	Lincoln, MT	ASARCO Incorporated
16	San Xavier	Pima, AZ	ASARCO Incorporated
17	Superior (Magma)	Pinal, AZ	Magma Copper Company
18	Miami	Gila, AZ	Pinto Valley Copper Corporation
19	Casteel	Iron, MO	The Doe Run Company
20	Silver Bell	Pima, AZ	ASARCO Incorporated
21	Lakeshore	Pinal, AZ	Cyprus Casa Grande Corporation
22	Johnson	Cochise, AZ	Arimetco Incorporated
23	Oracle Ridge	Pinal, AZ	South Atlantic Ventures Ltd.
24	Yerington	Lyon, NV	Arimetco Incorporated
25	Mineral Park	Mohave, AZ	Cyprus Mineral Park

(Source: U.S. DOI, Bureau of Mines 1993b)

In 1991, the consumption of copper and brass materials in the U.S. decreased by 4 percent from 1990 levels. Refined copper was used at approximately 20 wire-rod mills, 41 brass mills, and 750 foundries, chemical plants, and other manufacturers. The Bureau of Mines estimates that by year end 1992, United States, consumption of copper exceeded 2.1 million tons (U.S. DOI, Bureau of Mines 1993a).

Historically, the United States is one of the largest holders of refined copper reserves; it currently holds 16 percent of the world's reserves. More than 90 percent of the United States copper reserves are located in the top five copper-producing States. Copper reserves are defined by the U.S. Geological Survey (USGS) as that part of the resource base thought to be economically recoverable from operating or developing sites with existing technology. Copper reserves reported at operating or developing sites are anticipated to be sufficient to meet the projected cumulative demand of nearly 130 million tons of primary copper through the year 2000. In addition, some of the material already identified in the reserve base, once determined to be infeasible to mine, may become feasible with improved technology or higher copper prices.

The number of operating copper mines has decreased from 68 mines in 1989 to 65 mines in 1992. Of the 65 mines actively producing copper in the United States, 33 list copper as the primary product. The remaining 32 mines produce copper either as a byproduct or co-product of gold, lead, zinc, or silver (U.S. DOI, Bureau of Mines 1993b). Thirteen of the 33 active mines that primarily produce copper are located in Arizona; the remaining mines are located throughout New Mexico, Utah, Michigan, and Montana (U.S. DOI, Bureau of Mines, Unpublished).

In 1988, there were 17 copper mills using leaching methods in the United States, with total production of approximately 227,000 metric tons of electrowon copper (U.S. EPA 1989e; U.S. DOI, Bureau of Mines 1993b). According to the U.S. Bureau of Mines, in 1991 15.7 million metric tons of copper ore were beneficiated using leaching methods to recover 441,000 metric tons of copper (an increase of 194% in three years) (U.S. DOI, Bureau of Mines 1993b). While solution operations are conducted throughout the southwestern United States, almost 75 percent of the facilities (14) are located in Arizona. There are two facilities in New Mexico, one in Utah, and one in Nevada. An inventory and description of the 17 facilities that conduct leaching operations are provided in Table 1-2.

Use of the dump-leach method is common at the majority of solution operations, although an increasing number of facilities are now using underground leach methods. As an alternative to conventional surface or underground extraction techniques, *in situ* leach operations are becoming more commonplace in copper production operations. The majority of these techniques are used in old stopes or block-cave rubble where the ore deposit is disturbed. Another method, similar to underground leaching in existing mine workings is *in situ* leaching of undisturbed ore deposits. The difference being that the ore is leached in place. Such operations are considered experimental by the Bureau of Mines. Recent developments in copper solution mining technologies [e.g., *in situ* leaching, Solvent Extraction (SX), ion extraction, and Electrowinning (EW)] have significantly increased copper production from leaching operations. Many major copper mines have installed improved leach circuits, increasing their copper production by as much as 30 percent.

In 1989, approximately 50 percent of the solution operations used Solvent Extraction/Electrowinning (SX/EW) recovery methods; other mines employed cementation-type recovery units (U.S. DOI, Bureau of Mines, Unpublished). The growth in copper production that occurred in 1990 is largely the result of increases from SX/EW recovery. The SX/EW recovery of copper was 312,000 metric tons in 1989. It increased to 393,000 metric tons in 1990 and to 441,000 metric tons in 1991 (U.S. DOI, Bureau of Mines 1992, 1993b).

Table 1-2. Inventory of Active Copper Solution Mining Operations in the United States (1988)

Operation	Location	Leaching Method						Recovery Method		Capacity (Metric Tons)
		Underground Leach	In-situ*	Dump	Heap	Vat	Agitation	Pre-cipitation	SX/EW	
ASARCO, Inc. Ray Silver Bell	Hayden, Arizona Marana, Arizona			-	-			-	-	15,000/ 29,000 6,000
Battle Mountain Gold Co. Battle Mountain	Battle Mountain, Nevada			-					-	5,000
Cyprus Casa Grande Corp. Casa Grande	Casa Grande, Arizona		-						-	10,000
Cyprus Minerals Co. Bagdad	Bagdad, Arizona			-					-	6,800
Mineral Park	Kingman, Arizona			-				-		3,500
Sierrita/Esperanza	Sahuarita, Arizona			-				-		6,000
Cyprus Miami Kennecott	Claypool, Arizona			-	-				-	42,500
Bingham Canyon	Bingham Canyon, Utah			-				-		36,000
Kocide Chemical Van Dyke	Casa Grande, Arizona		-							NA**
Leaching Technology, Inc. Nacimiento	Cuba, New Mexico		-							NA**
Magma Copper Co. Miami Leach	Miami, Arizona	-							-	5,000
Pinto Valley	Miami, Arizona			-					-	16,000
San Manuel	San Manuel, Arizona	-		-					-	25,000
Phelps Dodge Corp. Chino	Hurley, New Mexico							-	-	52,000-
Copper Queen	Bisbee, Arizona	-						-		53,000
Morenci/Metcalf	Morenci, Arizona			-					-	2,500 155,000

\*Experimental only

\*\*NA - Not available

(Source: U.S. EPA 1989e)

### **1.3 ORE CHARACTERIZATION**

Copper is an element that occurs in minor amounts in the Earth's crust. Estimates of average crustal prevalence are on the order of 0.0058 percent by weight (U.S. DOI, Geological Survey 1973). Deposits considered to be economically recoverable at current market prices may contain as little as 0.5 percent of copper or less, depending on the mining method, total reserves, and the geologic setting of the deposit.

Copper deposits are found in a variety of geologic environments, depending on the rock-forming processes that occurred. In general, copper deposits are formed by hydrothermal processes (i.e., the minerals are precipitated as sulfides from heated waters associated with igneous intrusions or areas of otherwise abnormal lithospheric heating). Plate tectonic theory has provided a new framework for understanding the global distribution of ore deposits, since areas of plate divergences and convergences are where most hydrothermal activity occurs. These deposits can be grouped in the following broad classes: porphyry and related copper deposits, sediment-hosted copper deposits, volcanic-hosted massive sulfide deposits, veins and replacement bodies associated with metamorphic rocks, and deposits associated with ultramafic, mafic, ultrabasic, and carbonatite rocks. Each of these deposit classes is discussed further, below.

#### **1.3.1 Porphyry Copper and Associated Deposits**

The most commonly mined type of copper deposit, porphyry copper, occurs mainly in magmatic, volcanic arc, and back-arc tectonic regions of plates along modern or ancient subduction zones (plate-convergence boundaries). As a consequence, it is found predominantly in areas such as along the western continental edges of North and South America (U.S. DOI, Bureau of Mines 1992). Major copper porphyry deposits are also located in the southwestern United States, associated with large granitic intrusions.

Copper porphyry deposits are a type of disseminated mineral deposit, found dispersed throughout small fractures in porphyritic felsic intrusives (granitic rocks with large feldspar or quartz crystals in a finer matrix). By an unknown process, intrusive granitic plutons are fractured into pieces and the tiny veins and pore fillings are filled with the hydrothermal solutions, recementing the rock with the mineral-laden deposits. When the host rock is limestone, the resulting deposits are called "skarn" deposits. Because the copper is so physically dispersed, these ore deposits are considered low-grade, requiring large-scale mining methods (e.g., open pit) (Press and Siever 1978).

Porphyry copper deposits and their associated skarn, hydrothermal veins, and replacement breccia deposits were the predominant class of deposits mined in 1989 (59 percent of total world mining). These deposits made up 93 percent of the United States copper mine capacity in 1990 (U.S. DOI, Bureau of Mines 1992). The largest mines of this type in the United States are the Morenci Mine, Arizona, and the Bingham Canyon Mine, Utah.

#### **1.3.2 Sedimentary and Metasedimentary Deposits**

Sedimentary copper deposits generally occur in rocks formed in passive continental margin and interior environments and along intracontinental rift systems. These types of copper ores are chemical precipitates formed from copper-bearing hydrothermal brines that percolate through the sediments, or minerals that are redistributed by later metamorphic activity. Stratiform sedimentary and metasedimentary deposits are an important source of copper, making up 24 percent of the worldwide copper mining activity. Mining of this class of deposits in the United States represented 6 percent of the copper mining capacity in 1990 (U.S. DOI, Bureau of Mines 1992).

### **1.3.3 Volcanogenic Massive Sulfide Deposits**

Copper deposits found in ultramafic sequences were probably generated at ocean plate spreading centers. Because copper-bearing massive sulfides are associated with the submarine volcanic activity in these tectonic settings, deposits are commonly found in ophiolite rock formations. While volcanogenic and vein copper deposits are more numerous than porphyry- and sedimentary-type deposits, they are generally smaller in both capacity and reserves. Volcanogenic deposits made up 7 percent of the worldwide copper mining activity in 1989 (U.S. DOI, Bureau of Mines 1992).

### **1.3.4 Veins and Replacement Deposits**

Copper found in veins was deposited along rock joints, fractures, faults, bedding planes, or other zones of structural weakness through which the mineral-bearing hydrothermal solutions were able to percolate. Vein deposit morphology is typically tabular, with varying degrees of uniformity in thickness. Replacement deposits result when relatively low temperature ore-depositing fluids dissolve the mineral in place and an equal volume of new crystal is formed (Press and Siever 1978). Vein and replacement-type copper deposits made up 7 percent of the worldwide copper mining activity in 1989 (U.S. DOI, Bureau of Mines 1992).

### **1.3.5 Ultrabasic and Carbonatite Deposits**

Copper-bearing alkaline ultrabasic rocks and carbonatites intrude stable continental cratons, presumably related to mantle-derived magmas associated with intracontinental hotspots. Ultrabasic and carbonatite copper deposits made up 4 percent of the worldwide copper mining activity in 1989 (U.S. DOI, Bureau of Mines 1992).

### **1.3.6 Mineral Assemblages**

Copper occurs in about 250 minerals; however, only a few of these are commercially important. The mineral assemblage of a copper deposit is the result of reactions between hydrothermal solutions and the host rock, influenced by wall rock chemistry, solution chemistry, temperature, and pressure. Most copper ores contain some amount of sulfur-bearing minerals. The weathering environment affecting the ore body following deposition is determined mainly by the availability of oxygen. Ores exposed to air tend to be oxidized, while those in oxygen-poor environments remain as sulfides.

The most common sulfide minerals are chalcopyrite ( $\text{CuFeS}_2$ ), covellite ( $\text{CuS}$ ), chalcocite ( $\text{Cu}_2\text{S}$ ), bornite ( $\text{Cu}_5\text{FeS}_4$ ), enargite ( $\text{Cu}_3\text{AsS}_4$ ), and tetrahedrite ( $(\text{CuFe})_{12}\text{Sb}_4\text{S}_{13}$ ). Predominant oxide minerals are chrysocolla ( $\text{CuSiO}_3$ ), malachite ( $\text{Cu}_2\text{CO}_3$ ), azurite ( $\text{Cu}_3(\text{CO}_3)_2(\text{OH})_2$ ), and cuprite ( $\text{Cu}_2\text{O}$ ). Chalcopyrite is the most common mineral found in porphyry-type deposits. Chalcocite occurs predominantly in hydrothermal veins (U.S. DOI, Geological Survey 1973).



## **1.4 COPPER EXTRACTION AND BENEFICIATION PRACTICES**

### **1.4.1 Extraction Operations**

#### **1.4.1.1 Typical Mining Operations**

Extraction is the operation of physically removing ore from deposits in the earth. There are three basic methods of extracting copper ore: surface, underground, and solution mining. Surface and underground mines usually operate independently of each other, although underground techniques are sometimes used before and/or after surface methods. Some open-pit surface operations extract massive sulfide deposits and intersect abandoned underground workings that were closed due to the low grade (or lack) of oxide and sulfide ore.

Open-pit mining is the predominant method used today by the copper mining industry. This is due primarily to inherently high production rates, relative safety, low costs, and flexibility in extraction. According to the U.S. Bureau of Mines (1993b) open-pit mines represent 83 percent of domestic mining capacity. The remaining 17 percent of the active copper mines use various types of high-tonnage underground operations. Underground mining operations are used to mine deeper, and richer ore bodies. Factors influencing the choice of mining method include the size, shape, dip, continuity, depth, and grade of the ore body; topography; tonnage; ore reserves; and geographic location.

Solution mining of copper oxide and sulfide ores has increased since 1975. In this method, dilute sulfuric acid is percolated through ore contained in dumps, on leach pads, or underground leaching of broken rubble in or around formerly active stopes. Experimental work on *in situ* leaching, where the ore is leached in place, is also being conducted. The copper-bearing pregnant leach solution (PLS) is collected, and copper is recovered by SX/EW or precipitation methods. Solution mining has enabled facilities to beneficiate lower-grade sulfide and oxide ores.

#### **1.4.1.2 Surface Mining Methods**

As indicated above, most copper is produced by surface mining methods. Surface mining involves the excavation of ore from the surface by removing overburden (nonmineralized soil and rock that cover an ore body) and waste rock (poorly mineralized or very low-grade soil and rock that are within the ore body or surrounding it) to expose higher-grade minerals. In general, overburden is removed as efficiently and rapidly as possible, usually with little comminution. Overburden piles compose the largest volume of wastes generated by surface extraction activities (Beard 1990).

Advantages of surface mining operations, as compared to underground operations, include flexibility in production rates without deterioration of workings, relative safety for workers, ability to practice selective mining and grade control, and low cost per ton of ore recovered. Surface mining also has lower development and maintenance costs than underground mining because it requires fewer specialized systems. During expanded development, however, some surface mines with large amounts of prestripping waste could have higher costs than established underground mines.

Open-pit mining is most common in the copper mining industry because the ore body being mined is large and the overburden depth is usually limited. Open-pit mine designs are based on the configuration of the ore body, the competence of the rock, and other factors. The mine shape is formed by a series of benches or terraces arranged in a spiral or in levels with interconnecting ramps. Open-pit mines may reach several thousand feet below the surface. The different stages of open-pit mining are depicted in Figure 1-1.

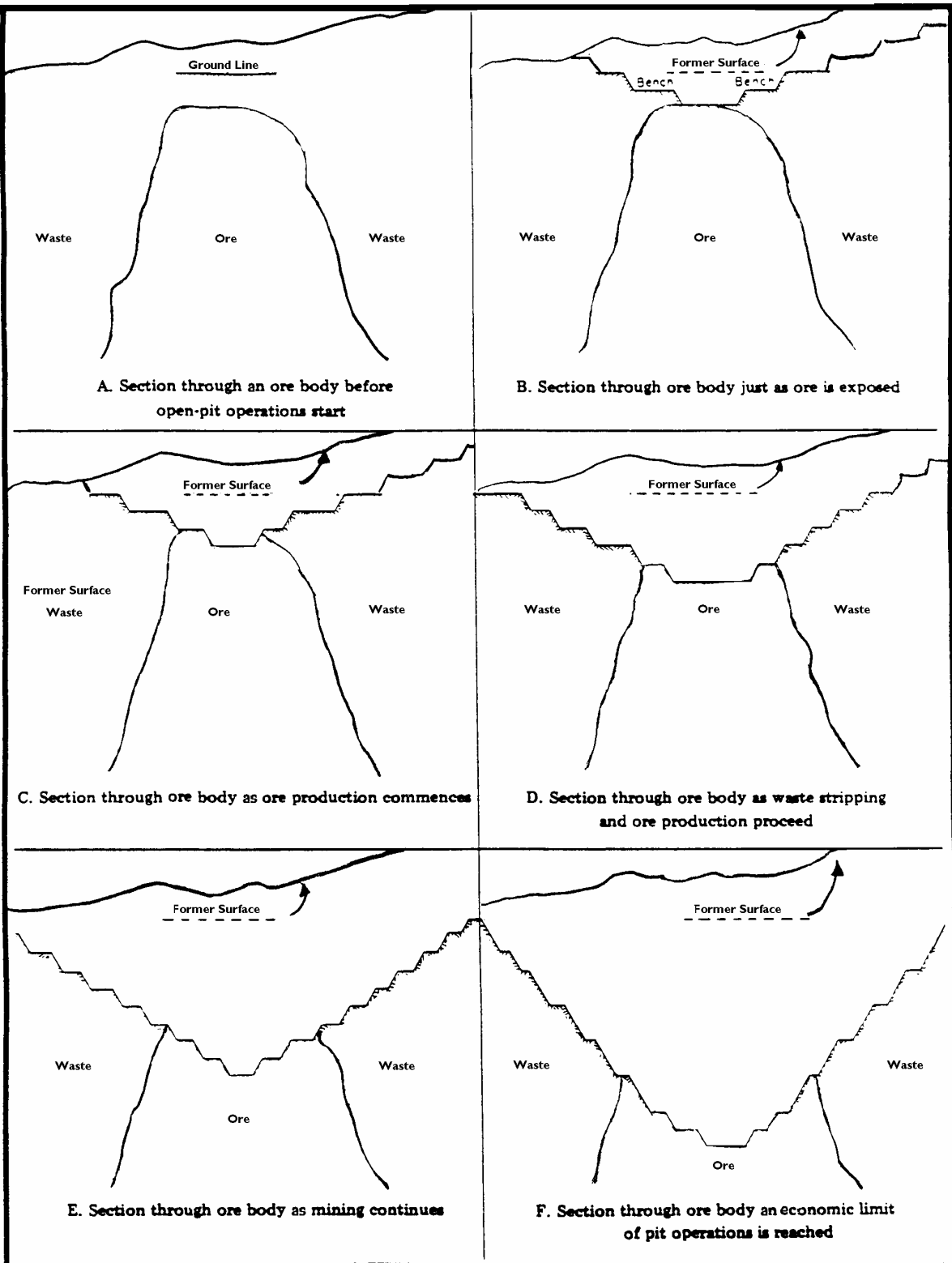

Figure 1-1.States of Open-Pit Mining

(Source: Stout 1980)

In the development stage, overburden is stripped off to expose the ore. The waste and ore are excavated by drilling rows of 6- to 12-inch (diameter) blast holes. Samples from the blast holes are analyzed to determine the grade. The blast holes are filled with a mixture of ammonium nitrate and fuel oil (ANFO) type explosive. Most mining operations use nonelectric caps and delays to control the blasting sequence. Usually, an entire segment of a bench is "shot" at one time. Subsequently, large electric or diesel shovels or front-end loaders transport the ore onto trucks, trains, or conveyor belts for removal to milling or leaching facilities, depending on the type of ore (sulfide or oxide) and grade. A pneumatic or hydraulic impact hammer, similar to a jackhammer, is used to break up waste and ore too large to handle in the pit or in subsequent crushing operations.

#### 1.4.1.3 Underground Mining Methods

Underground mining methods are usually employed to mine richer, deeper, and smaller ore bodies where open-pit methods would be impractical. Underground mining operations are complex combinations of tunneling, rock support, ventilation, electrical systems, water control, and hoists for the transportation of people, ore, and materials. The three main underground mining methods used to mine copper ore are stoping, room-and-pillar, and block caving. All of these methods can be used in several variations, depending on the characteristics of the ore body.

Common stoping methods include cut-and-fill (see Figure 1-2a), square-set (timbered) stoping, open stoping, shrinkage stoping, sublevel stoping, and other variations. In general, all these underground operations involve sinking a vertical shaft or driving a horizontal adit, both of which provide access to the ore body. This type of extraction technique is best adapted to steeply dipping vein-type deposits. Today, underground operations using stoping methods are usually byproduct producers of copper and have relatively low copper tonnages (Stout 1980).

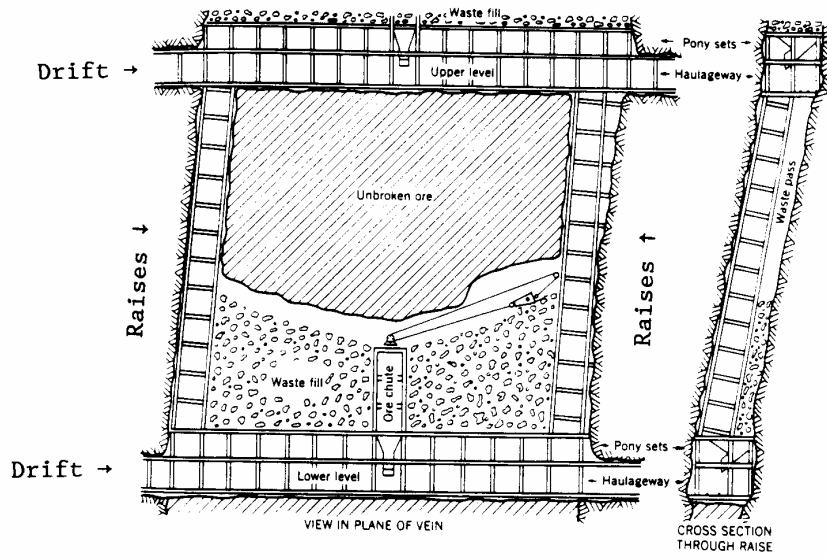

a. Cut-and-Fill Operation

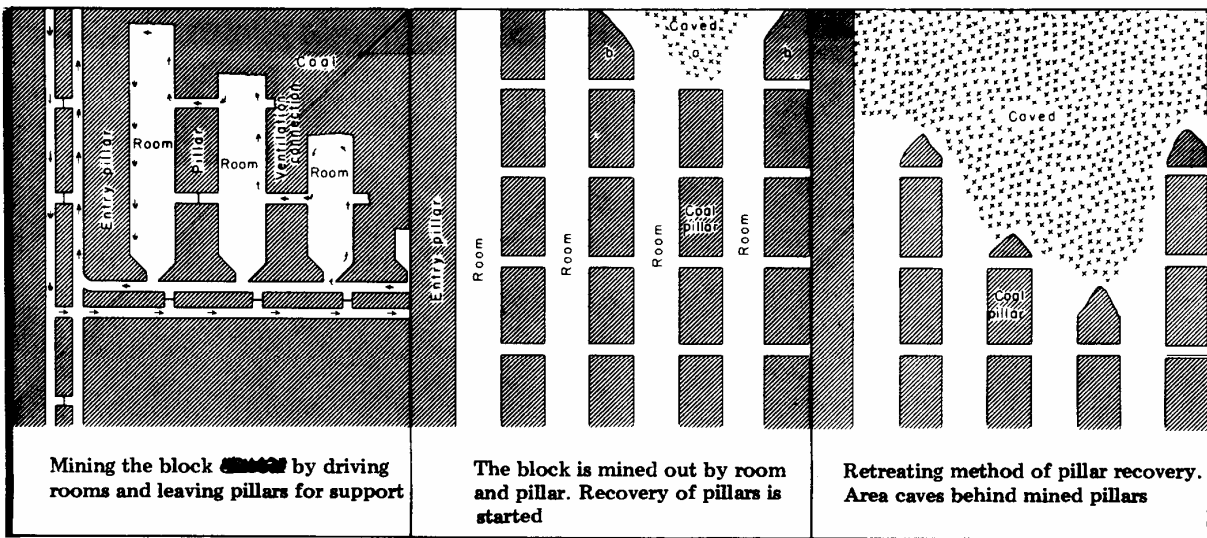

b. Room-and-Pillar Operation

Figure 1-2. Cut-and-Fill and Room-and-Pillar Underground Mining Methods

(Source: U.S. DOI, Bureau of Mines 1965a; Stout 1980)

Most underground stope mines are designed with two or more shafts and a series of parallel drifts, known

as levels, which intersect the main shaft. Ore mining occurs in areas between adjacent levels in irregular cavities called stopes (see Figure 1-2a). The stopes are connected to the levels by tow raises (one on each side of the block of ore to be mined), manways (to provide access), and chutes (to remove the ore). The ore is drilled and blasted at the face of the stope, then raked (or mucked) down a chute. The chutes are located above the main haulage drifts and intercept them. The ore is loaded onto rail or rubber tire ore cars that haul it to the shaft. It is then dumped into another chute that feeds the ore into buckets that are hoisted to the surface. Waste rock, known as mine development rock (material removed to access the ore body), is handled the same way, except that it is hauled to an adjacent stope. There, it is dumped into a raise that feeds into a stope where it is backfilled to provide a working area to drill out the next ore cut (Stout 1980).

Room-and-pillar mining operations produce more tonnage than any other type of mine operation. Room-and-pillar operations are best adapted to mining large, flat deposits or massive deposits where sequential slices or levels may be mined. Mining is conducted in a nearly horizontal or horizontal altitude. Depending on the access design for the deposit, vertical shafts or relatively horizontal inclines or declines may be used. A double entry system is designed to provide ventilation, men and materials access, and ore transport (Stout 1980).

A typical room-and-pillar operation is illustrated in Figure 1-2b. Usually, ore is mined in two phases, the first phase involves driving large horizontal drifts (called rooms) parallel to each other and smaller drifts perpendicular to the rooms. The area between the intersection of the rooms and drifts forms the pillars, which support the roof. Rooms vary in size from 6 to 60 feet high and 10 to 100 feet wide. The size of each room and pillar is dependent on the quality of the rock. Between 30 and 60 percent of the ore remains unmined in the pillars. Once the mine reaches the end of the ore body, the second phase of operations may begin to recover the ore left behind in the pillars. Starting from the back of the mine and working forward, the pillars are mined out one at a time, a technique called "pillar robbing." Timbers are used to temporarily support the roof. Once a pillar is mined out, the timbers are removed and the ground is allowed to collapse. This procedure is called "retreating" and produces ore at a relatively low cost per ton (Stout 1980).

Block caving (depicted in Figure 1-3) is a third large-tonnage underground mining method used to mine copper. This method includes undercut block and sublevel block caving. The block-caving method of mine development utilizes the natural forces of gravity to cause the ore to break on its own accord without being drilled and blasted. A typical block-caving mine is developed by first driving a series of parallel haulage drifts below the ore body. From the haulage drifts, a series of raises are driven at a 45-degree angle forming the grizzly level. A second set of finger raises are driven perpendicular to the inclined grizzlies. The grizzlies and finger raises are spaced at suitable intervals to produce effective caving. The ends of the finger raises are star drilled or ring drilled with a series of drillholes radiating out from the raise and blasted together. This creates the cavities that start the caving process (Stout 1980).

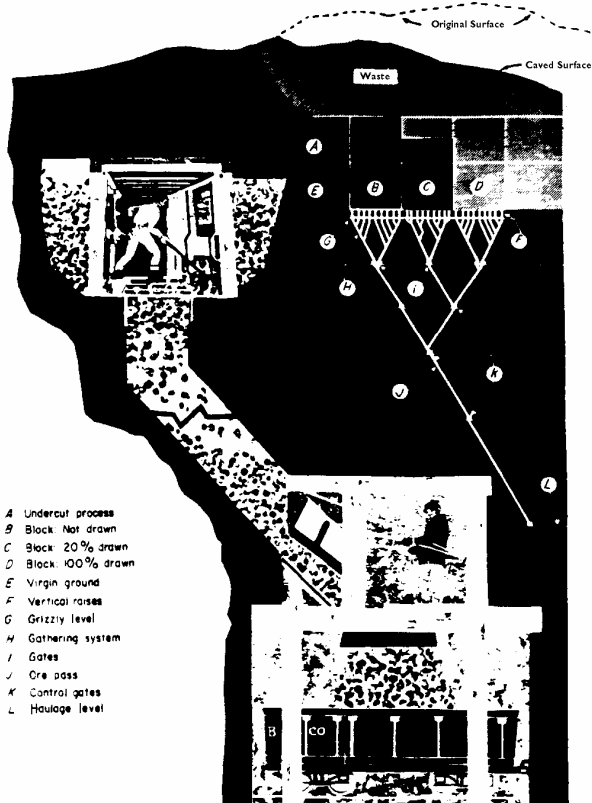
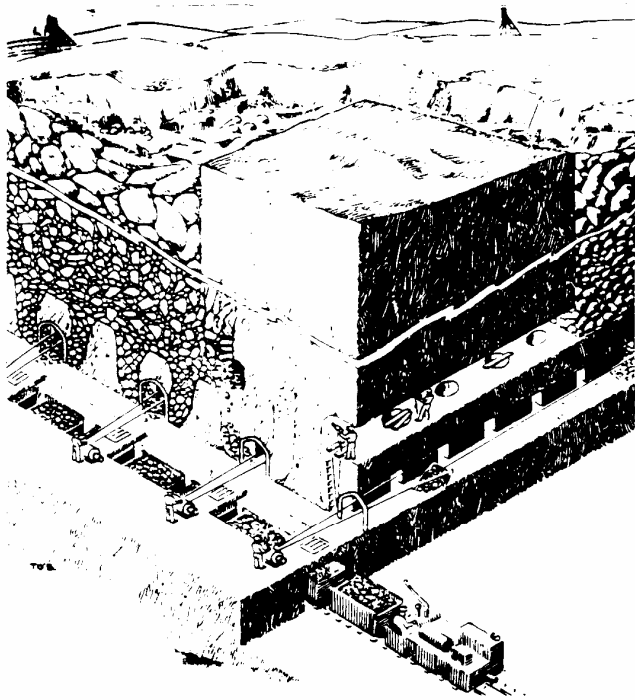

(Source: Stout 1980)

**Figure 1-3. Block-Caving Methods**

(Source: Stout 1980)

The caving action is caused by the ore caving under its own weight into a large cavity in the stopes. Because the broken ore takes up more volume than the solid ore, the stope fills up; this, in turn, stops the caving process. As the broken ore is mucked or slushed (i.e., pulled) from the back of the stope by drawing ore from the raises, a cavity is created which restarts the caving process. The more rapid the withdrawal rate, the more rapid the caving action. Consequently, raises must be "pulled or mucked" evenly to ensure uniform caving (Stout 1980).

## **1.4.2 Beneficiation Operations**

Beneficiation of ores and minerals is defined in 40 CFR 261.4 as including the following activities: crushing; grinding; washing; filtration; sorting; sizing; gravity concentration; flotation; ion exchange; solvent extraction; electrowinning; precipitation; amalgamation; roasting; autoclaving; chlorination; and heap, dump, tank, and *in situ* leaching. The beneficiation method(s) selected varies with mining operations and depends on ore characteristics and economic considerations.

### 1.4.2.1 Conventional Milling/Flotation

This section describes the typical stages in the conventional milling/flotation of sulfide ores. A flowsheet illustrating this process is presented in Figure 1-4.

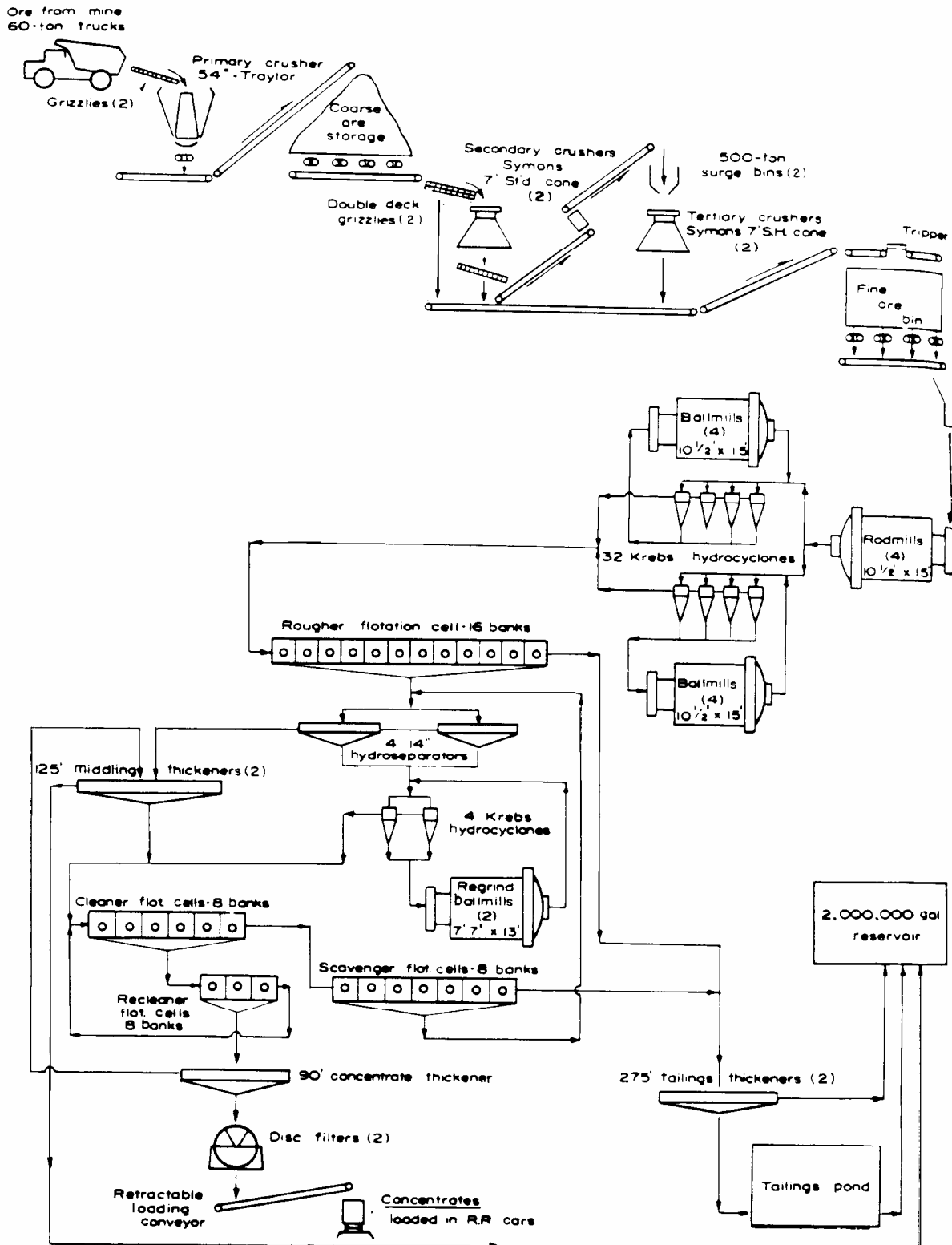

Figure 1-4. Flowsheet for Sulfide Ore Beneficiation

(Source: U.S. DOI, Bureau of Mines 1965a)



### Crushing and Grinding (Comminution)

The first step in beneficiation is comminution. Typically, this is accomplished by sequential size reduction operations—commonly referred to as crushing and grinding. Crushing may be performed in two or three stages. Primary crushing systems consist of crushers, feeders, dust control systems, and conveyors used to transport ore to coarse ore storage. Primary crushing is often accomplished by a jaw or gyratory crusher, since these units can handle larger rocks. Figure 1-5a shows a typical jaw-type crusher. Cone crushers, shown in Figure 1-5b, work best at large, high-capacity operations because they can handle larger tonnages of material. The feed to primary crushing is generally run-of-mine ore, which is reduced from large pieces (2 to 4 feet in dimension) to smaller pieces (8 to 10 inches in dimension). Primary crushing systems are typically located near or in the pit at surface mines or below the surface in underground mines. Crushed ore is then transferred to secondary crushers, usually located near the next step in beneficiation. The ore may be temporarily stored in piles at the site.

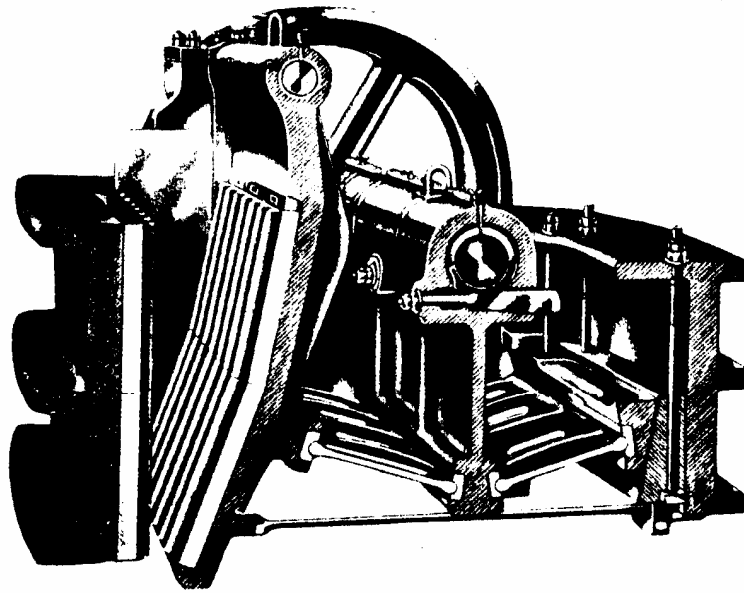

**a. Cross-Section of a Jaw-Type Crusher**

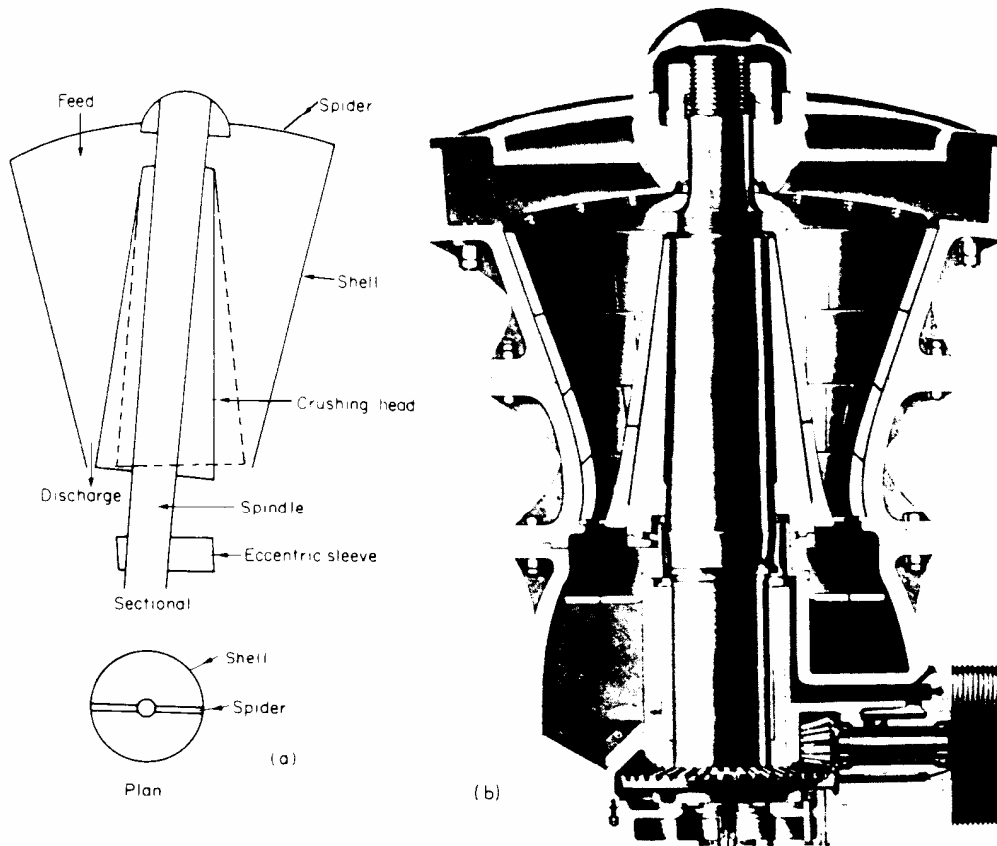

**b. Functional Diagram and Cross-Section of a Cone-Type Crusher**

**Figure 1-5. Typical Crushers**

(Source: Wills 1981)

Secondary and tertiary crushing usually are performed in surface facilities in cone crushers, although roll crushing or hammer mills are sometimes used. In these reduction stages, ore must be reduced to about 0.75 inches before being transported (usually on conveyer belts) to a grinding mill (U.S. Congress, Office of Technology Assessment 1988; Taggart 1945; Wills 1981).

Size separators (such as grizzlies and screens) control the size of the feed material between the crushing and grinding stages. Grizzlies are typically used for very coarse material. Screens mechanically separate ore sizes using a slotted or mesh surface that acts as a "go/no go" gauge. Vibrating and shaker screens are the most commonly used types of separators. There are many different types of vibrating screens, designed to handle material between 25 centimeters (cm) and 5 mm. After the final screening, water is added to the crushed ore to form a slurry (U.S. Congress, Office of Technology Assessment 1988; Taggart 1945; Wills 1981).

Grinding is the last stage in comminution. In this operation, ore particles are reduced and classified (typically in a hydrocyclone) into a uniformly sorted material between 20 and 200 mesh. Most copper facilities use a combination of rod and ball mills to grind sulfide ore (Figures 1-6a and b). Rod mills use free steel rods in the rotating drum to grind the ore. A ball mill works by tumbling the ore against free steel balls and the lining of the mill. Rod and ball mills are constructed with replaceable liners composed of high-strength chrome-molybdenum steel bolted onto the mill shell. The grinding face of the liner is ribbed to promote mixing. The liners require extensive maintenance and must be replaced regularly. To replace the liner, the mill must be taken out of production. A shutdown of a mill requires additional milling capacity to prevent overall mill shutdowns during maintenance (U.S. Congress, Office of Technology Assessment 1988; Taggart 1945; Wills 1981). In some cases, ore and water are fed into an autogenous mill (where the grinding media are the hard ores themselves), or a semiautogenous mill (where the grinding media are the ore supplemented by large steel balls).

Typically, grinding circuits are organized in series configuration as shown in Figure 1-6c. Each unit in the series produces successively smaller material. Typically, crushed ore and water enter the rod mill. When the material is reduced to a certain particle size, it becomes suspended in the slurry (because of its size and specific gravity and the motion of the mill). The fine material then floats out in the overflow from the mill (U.S. Congress, Office of Technology Assessment 1988; Taggart 1945; Wills 1981). At this point, the ore slurry is classified according to particle size in a hydrocyclone or similar device. Oversize material passes to the ball mill for additional grinding. Undersize material moves to the next phase of beneficiation.

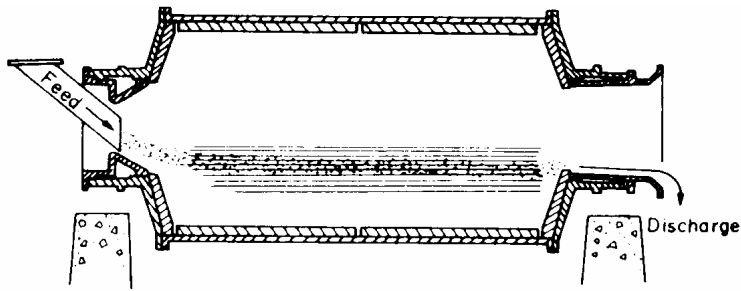

**a. Rod Mill**

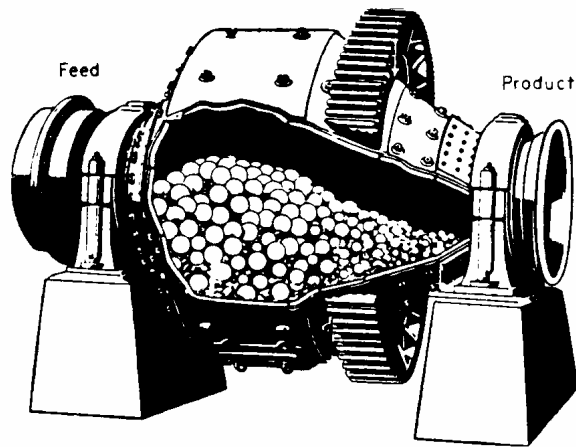

**b. Ball Mill**

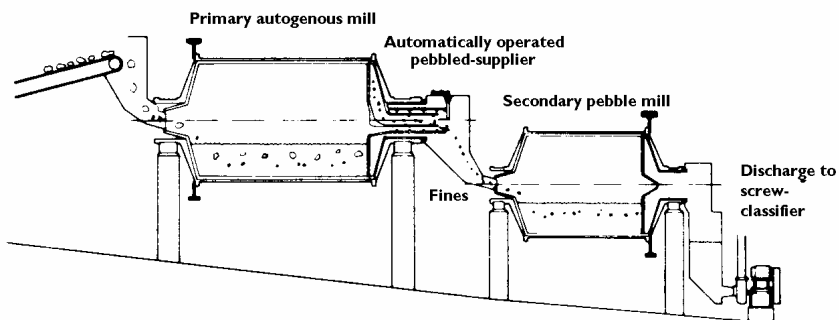

**c. Grinding Circuit**

**Figure 1-6. Typical Milling Units**

(Source: Wills 1981)

After grinding, ore is pumped to a classifier designed to separate fine-grained material (less than 5 mm) from coarse-grained material requiring further grinding. This method is used to control both under and over milling or grinding. Classification is based on differences in the size, shape, density, and settling rate of particles in a liquid medium (i.e., water). Various kinds of hydraulic classifiers are used. These generally fall into two categories: horizontal, and vertical current classifiers. Mechanical classifiers (shown in Figure 1-7a) are horizontal current classifiers, which are no longer in wide use. The hydrocyclone (see Figure 1-7b) is the standard technology for vertical classifiers in use today (U.S. Congress, Office of Technology Assessment 1988; Taggart 1945; Wills 1981).

**b. Hydrocyclone (New Technology)**

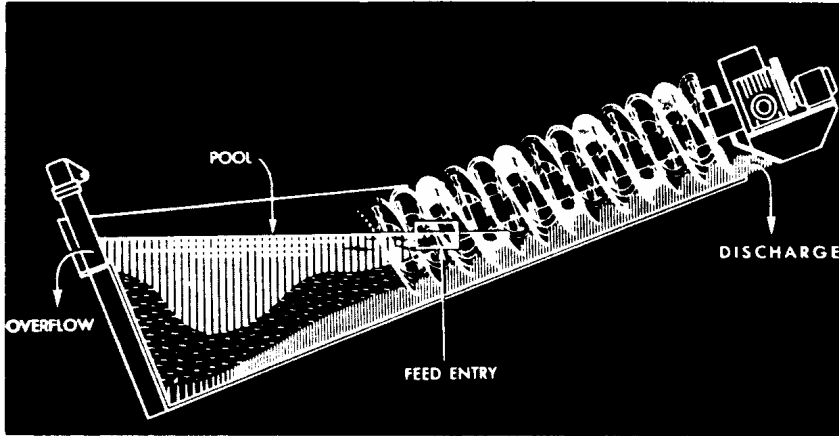

a. Mechanical Classifier (Old Technology)

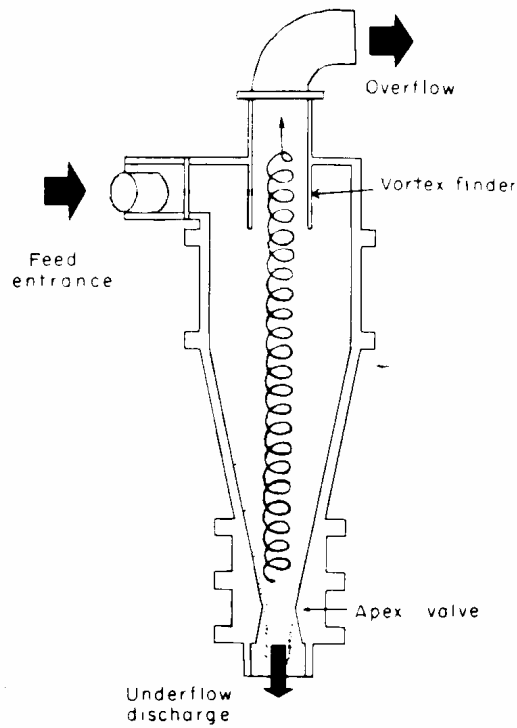

Figure 1-7. Classifiers

(Source: Wills 1981)

Flotation

The second step in the beneficiation of sulfide ore is concentration. The purpose of concentration is to separate the valuable mineral (or "values") from nonvaluable minerals (referred to as "gangue"). There are a variety of concentration methods. Selection of a method (or methods) to use for a particular ore is based on the ore mineralogy and mineral liberation size. Froth flotation is the standard method of concentration used in the copper industry. About 75 percent of all copper is produced by this method. The most significant technological development in flotation in recent years is the column flotation cell, which is being installed at most concentrators (Berkeley Study 1985).

One of the advantages to the flotation method is that it makes the recovery of molybdenum [as molybdenite ( $\text{MoS}_2$ )] by selective flotation viable at some properties. The recovery of molybdenite, when the molybdenum price is adequate, can provide a significant portion of a mine's revenue. In addition to the byproduct of molybdenum, most of the precious metals in the copper concentrate are recovered in anode slimes during subsequent electrorefining steps. As of 1985, there were eight copper and seven copper-molybdenite froth-flotation-type concentrators in the United States (Berkeley Study 1985; U.S. DOI, Bureau of Mines 1987a; U.S. Congress, Office of Technology Assessment 1988).

Currently, there are 11 copper flotation concentrators in operation in Arizona and New Mexico. ASARCO operates four (Ray, Mission, and two newly opened facilities), Cyprus operates two (Bagdad and Sierrita); Magma operates three (San Manuel, Pinto Valley, and Superior); and Phelps Dodge operates two (Tyrone and Chino). Three other concentrators are on stand-by: ASARCO's Silver Bell facility, Cyprus' Esperanza facilities, and Phelps Dodge's Ajo facility.

Typical flotation cells are depicted in Figure 1-8. In general, they resemble a large washing machine that keeps the particles in suspension through agitation. The ore is first conditioned with chemicals to make the copper minerals water-repellent (i.e., hydrophobic) without affecting the other minerals. Air is then pumped through the agitated slurry to produce a bubbly froth. The hydrophobic copper minerals are aerophillic, that is they are attracted to air bubbles, to which they attach themselves, and then float to the top of the cell. As they reach the surface, the bubbles form a froth that overflows into a trough for collection. The minerals that sink to the bottom of the cell and are removed for disposal (Wills 1981).

Denver D-R Flotation Cells

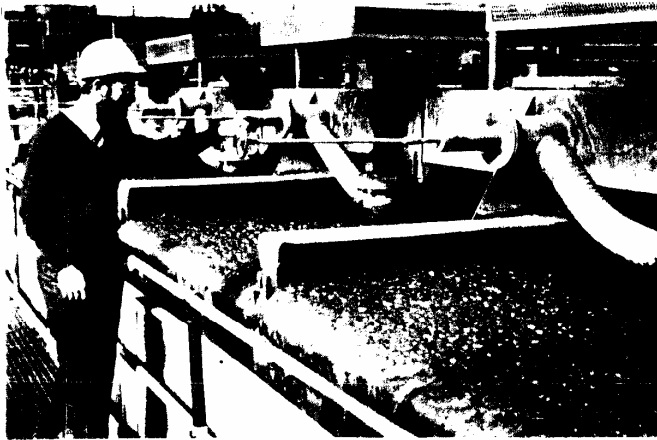

Denver Sub-Aeration Cell

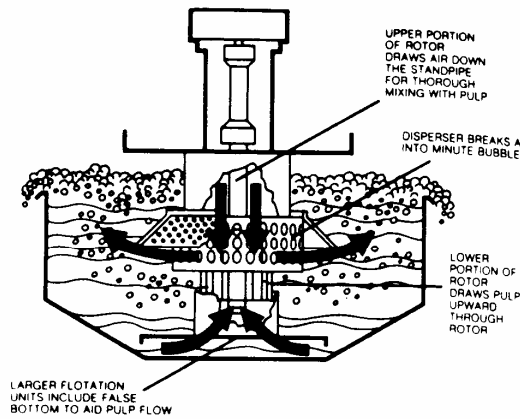
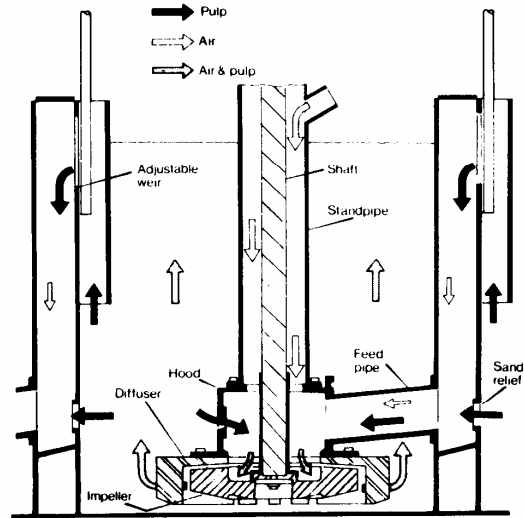

Wemco Fagergen Cell

Figure 1-8.Types of Flotation Cells

(Source: Wills 1981; U.S. Congress, Office of Technology Assessment 1988)

The simplest froth flotation operation is the separation of sulfide minerals from gangue minerals (such as



limestone or quartz). The separation of different types of sulfide minerals, such as chalcopyrite, from pyrite is more complex, because the surfaces of the minerals have to be modified so that the reagents attach only to the mineral to be floated. In practice, each ore is unique; consequently, there is no standard flotation procedure. Once the unit is operational, continued monitoring of the ore feed mineralogy is critical to fine-tune the flotation units when changes occur. These changes occur because ore bodies are not homogeneous; variations in feed and mineralogy are normal and may require circuit modifications (Biswas and Davenport 1976; Taggart 1945; Wills 1981).

Conventional flotation is carried out in stages. The purpose of each stage depends on the types of minerals in the ore. Selective flotation of chalcocite-bearing sulfide ores and the rejection of pyrite utilizes three types of flotation cells: roughers, cleaners, and scavengers. Roughers use a moderate separating force to float incoming ore and to produce a medium-grade concentrate. Cleaners use a low separating force to upgrade the rougher concentrate by removing additional pyrite and gangue waste material to produce a high-grade concentrate. Scavengers provide a final, strong flotation treatment for the rougher tailings by using a strong concentration of reagents and vigorous flotation to recover as much of the remaining sulfide minerals as possible. The float from the scavenger flotation is often recycled through a regrinding mill and sent back to the rougher flotation cells. Throughout the operation, the pyrite is depressed by employing a modifying agent, such as lime, for pH control (U.S. Congress, Office of Technology Assessment 1988; Biswas and Davenport 1976; Taggart 1945; Wills 1981).

Because flotation is partially dependent on ore particle size, regrinding of the particles between the rougher and cleaner flotation cells may be needed. Tailings from the cleaner flotation may be sent back to the flotation circuit for additional recovery (Biswas and Davenport 1976; U.S. DOI, Bureau of Mines 1965a; Wills 1981).

For more complex ores, the first stage of flotation is often a bulk float. This is similar to the rougher stage, in which much of the waste and some of the byproduct metals are eliminated. The bulk concentrate goes to roughers (which float specific types of sulfides) and then to cleaners. Again, a regrinding circuit may be needed between rougher cells (Biswas and Davenport 1976; U.S. DOI, Bureau of Mines 1965a; Wills 1981).

Froth flotation is carried out using reagents that, when dissolved in water, create hydrophobic forces that cause the values to float. Reagents can be added prior to entering the initial rougher flotation stage and/or during subsequent steps in the flotation operation. The reagents used in flotation concentrators are called collectors, depressants, activators, frothers, flocculants, filtering aides, and pH regulators. A complete list of the reagents typically used in a copper flotation circuit is presented in Table 1-3 (Biswas and Davenport 1976; U.S. DOI, Bureau of Mines 1987a).

Table 1-3.Reagent Consumption at U.S. Copper Sulfide Concentrators in 1985

Copper Froth Flotation		Molybdenum Copper	
	Amount*		Amount*
<b>Flotation Reagents</b>		<b>Flotation Reagents</b>	
Collectors		Collectors	
Ethylxanthate	632	Ethylxanthate	417
Amyl xanthate	307	Amyl xanthate	261
Isopropylxanthate	154	Isopropylxanthate	70
Alkyl dithiophosphate	629	Isobutylxanthate	123
Thionocarbamate	146	Unspecified xanthates	224
Mixtures of thio reagents	338	Alkyl dithiophosphate	405
Unspecified thio reagents	26	Unspecified dithiophosphate	62
<b>TOTAL</b>	<b>2,232</b>	Xanthogen formate	48
Depressants		Thionocarbamate	709
Cyanide salt	5	Unspecified sulfide collector	765
Frothers		Fuel oil	2,207
Aliphatic alcohol	1,044	Kerosene	55
Pine oil	271	<b>TOTAL</b>	<b>5,346</b>
Polyglycol ether	20	Depressants	
Unspecified polyol	1,566	Phosphorous pentasulfide	1,926
<b>TOTAL</b>	<b>2,901</b>	Cyanide salt	3,652
Flocculants		Sulfide salt	19,649
Aluminum salts	155	Sodium silicate	102
Anionic polyacrylamide	74	<b>TOTAL</b>	<b>25,329</b>
Nonionic polyacrylamide	111	Activators	
Unspecified polymer	113	Sodium sulfide or hydrosulfide	<b>14,613</b>
<b>TOTAL</b>	<b>453</b>	pH Regulators	
		Sulfuric acid	2,203
		Caustic soda (NaOH)	3
		<b>TOTAL</b>	<b>2,206</b>
		Frothers	
		Aliphatic alcohol	2,936
		Pine oil	227
		Phenol	777
		Polyglycol ether	219
		Unspecified polyol	587
		<b>TOTAL</b>	<b>4,746</b>
		Flocculants	
		Anionic polyacrylamide	157
		Nonionic polyacrylamide	52
		Polyacrylate	374
		Unspecified polymer	66
		<b>TOTAL</b>	<b>649</b>
		Dispersants	
		Sodium silicate	51
		Polyphosphate	273
		<b>TOTAL</b>	<b>324</b>
<b>TOTAL</b>	<b>5,591</b>	<b>TOTAL</b>	<b>53,213</b>
<b>pH Regulators</b>		<b>pH Regulators</b>	
Lime	224,268	Lime	357,129

\*Quantity in thousands of pounds  
 (Source: U.S. DOI, Bureau of Mines 1987a)

Ionic collectors are added to the ore slurry to create the hydrophobic surfaces on sulfide minerals. The best-known sulfide collectors are potassium and sodium xanthates. Other types of collectors are thionocarbomates, dithiophosphates, and thiocarbanilides. Kerosene and fuel oil are used as molybdenite collectors. The longer carbon-chain potassium amyl xanthate typically is used as a collector in scavenger flotation cells to promote flotation of difficult-to-float, partially oxidized sulfate-filmed copper minerals (Biswas and Davenport 1976; U.S. DOI, Bureau of Mines 1987a).

A copper collector typically is composed of a complex heteropolar molecule, which has a charged (i.e., negative) sulfur-bearing polar group end and a noncharged nonpolar group end. The nonpolar radical is a hydrocarbon that has pronounced water-repellant properties, whereas the polar group reacts with water and the copper mineral surface (see Figure 1-9a). The reaction between sulfide minerals and sulfide collectors (such as xanthates) results in insoluble metal xanthates that are strongly hydrophobic. The copper sulfide mineral becomes a surface covered with air-avid hydrocarbon nonpolar ends seeking an air bubble attachment (Wills 1981).

Mechanical flotation cells (see Figure 1-9b) introduce air into the slurry, creating dispersed bubbles to which the hydrophobic complexes attach (and on which they then float to the surface). Frothers are chemically similar to ionic collectors; they absorb on the air-water interface and reduce the surface tension, thus stabilizing the bubbles. The resultant froth must be short-lived and self-deteriorating or the flotation units would be enveloped in foam. Standard frothing agents used in copper and copper-molybdenite concentrators include alcohols, pine oil, and polyglycol ethers (Biswas and Davenport 1976; U.S. DOI, Bureau of Mines 1987a).

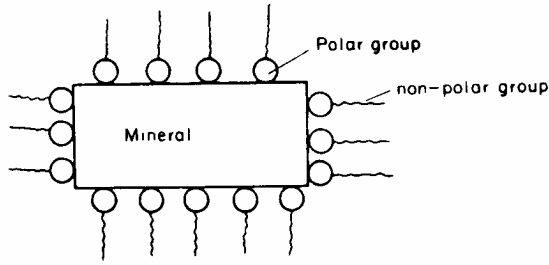

a. Collector Adsorption on Mineral Surface

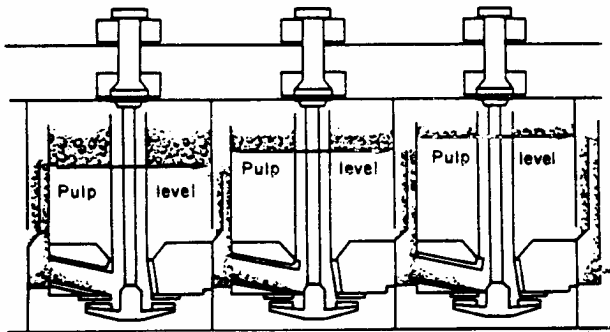

b. Bank of Flotation Cells

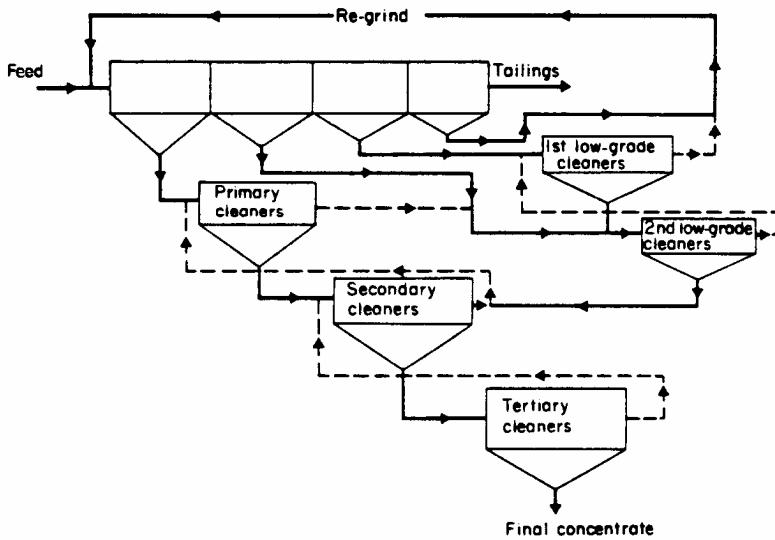

c. Complex Flotation Circuit

Figure 1-9. Flotation

(Source: Wills 1981)

Differential flotation for complex ores that contain sulfides (other than copper sulfides) requires the use of reagents that modify the action of the collector either by intensifying or reducing its water-repellant effect on the valuable mineral surface (Figure 1-9c). These reagents are known as modifiers or regulators or, in copper-molybdenite concentrators, as depressants and activators. The most common modifier is the OH (hydroxyl) ion. Lime or sodium carbonate is used to raise the pH of the slurry and regulate the pulp alkalinity. The second most common modifier in copper flotation is the cyanide ion derived from sodium cyanide. It is normally used to depress pyrite while floating chalcopyrite or chalcocite in rougher flotation. Standard activators used in the copper and copper-molybdenite flotation circuit for oxidized copper mineral surfaces are sodium sulfide and sodium hydrosulfide (Biswas and Davenport 1976; U.S. DOI, Bureau of Mines 1987a).

Copper mineral concentrate, the product of flotation, is then sent to a smelter for processing. The waste material or tailings from this operation is sent to a tailings pond for disposal. Copper concentrates exiting the flotation circuit contain 60 to 80 percent water. Dewatering the concentrate in a thickener, then in disc or drum filters for final dewatering, produces a relatively dry product ready for further shipping and processing. The collected water is usually recycled to the milling circuit. The settling of solids in the thickeners is enhanced by chemical reagents known as flocculants. Filter cake moisture is regulated by reagents known as filtering agents. Typical flocculants and filtering agents used are polymers, nonionic surfactants, polyacrylate, and anionic and nonionic polyacrylamides (ASARCO 1991).

At most facilities, thickening of tailings is a common step prior to pumping the thickened slurry to the tailings pond and ultimately disposing of the thickened slurry. Thickening minimizes the amount of water placed in the pond and the pond size. The thickened tailings retain sufficient water to allow them to flow in the tailings pipeline without undue wear on the transport system (Arizona BADCT Draft).

Thickening is usually accomplished by settling in large tanks, known as thickeners. The settling of solids in tailings thickeners is also enhanced with flocculants. Gravity causes the flocculated solids to settle to the bottom of the thickener, where they are scraped to a discharge outlet by a slowly rotating rake. Collected water from this process is generally recycled back to the mill to be used in beneficiation activities (U.S. Congress, Office of Technology Assessment 1988; Biswas and Davenport 1976; U.S. DOI, Bureau of Mines 1987a; Wills 1981).

#### 1.4.2.2 Leach Operations (*In Situ*, Dump, Heap, and Vat)

Copper is increasingly recovered by solution, or hydrometallurgical, methods. These include dump, heap, and vat leaching techniques, as well as underground (or *in situ*) leaching methods. Each of these methods results in a pregnant leach solution (PLS). Copper is recovered from the PLS through precipitation or by solvent extraction/electrowinning (SX/EW) (U.S. Congress, Office of Technology Assessment 1988).

Characteristics of typical leaching operations are presented in Tables 1-4 and 1-5. Recent developments in SX/EW technology have made solution mining a major factor in copper production. Currently, solution copper mining techniques account for approximately 30 percent of domestic copper production. Two-thirds of all United States copper mines employ various types of solution operations. Solution mining generally has lower day-to-day operating costs than other mining methods (Weiss 1985).

**Table 1-4.Characteristics of Copper Leaching Methods**

	Vat Leaching	Heap Leaching	Dump Leaching	Underground and In situ Leaching
<b>Ore grade</b>	Moderate to high	Moderate to high	Low	Low to high (dependent upon mine conditions and layout)
<b>Types of ore</b>	Oxides, silicates, and some sulfides	Oxides, silicates, and some sulfides	Sulfides, silicates, and oxides	Oxides, silicates, and some sulfides
<b>Ore preparation</b>	May be crushed to optimize copper recovery	May be crushed to optimize copper recovery	Blasting	None
<b>Container or pad</b>	Large impervious vat	Impervious barrier of clay, synthetic material, or both	None for existing dumps; new dumps intended to be leached would be graded, and covered with an impermeable polyethylene membrane, or bedrock, protected by a layer of select fill	None
<b>Solution</b>	Sulfuric acid for oxides; acid cure and acid-ferric cure provide oxidant needed for mixed oxide/sulfide ores	Sulfuric acid for oxides; acid cure and acid-ferric cure provide oxidant needed for mixed oxide/sulfide ores	Acid ferric-sulfate solutions with good air circulation and bacterial activity for sulfides	Sulfuric acid, acid cure, acid-ferric cure, or acid ferric-sulfate, depending on the ore type
<b>Length of leach cycle</b>	Days to months	Days to months	Months to years	Months
<b>Solution application method</b>	Spraying, flooding, and circulation	Spraying or sprinkling	Ponding/flooding, spraying, sprinkling, and trickle systems	Injection holes, recovery holes
<b>Metal recovery method</b>	SX/EW for oxides and mixed oxide/sulfide ores; iron precipitation for mixed ores	SX/EW for oxides and mixed oxide/sulfide ores; iron precipitation for mixed ores	SX/EW for oxides and mixed oxide/sulfide ores; iron precipitation for mixed ores	SX/EW for oxides and mixed oxide/sulfide ores; iron precipitation for mixed ores

**Table 1-5.Background on Copper Leaching Methods**

(Source: U.S. Congress, Office of Technology Assessment 1988)

Leaching Method	Mineralization	Percent Copper in Ore	Sulfuric Acid Concentration in Leachate (kg/m <sup>3</sup> )	Copper Concentration in Pregnant Solution (kg/m <sup>3</sup> )	Leach Cycle	Representative Size of Operation	Copper Leached (metric tpd)
Dump	Sulfide or mixed oxide/sulfide	0.05+	1-5	1-2	3-30 years	5 x 10 <sup>6</sup> metric tons of ore	100
Heap	Oxide	0.5-1	2-10	2-5	1+ months	3 x 10 <sup>5</sup> metric tons of ore	20
Underground and In Situ	Oxide (with some sulfide)	0.5-1	3-50	3-10	1-25 years	4 x 10 <sup>6</sup> metric tons of ore	20
Vat	Oxide	1-2	50-100	30-40	5-10 days	6-12 vats	10-120
Agitation	Oxide	0.05+	50-100	30-50	2-5 hours	45 leach tanks 47 thickeners	350

(Source: U.S. EPA 1989e)

Most ores occur as mineral compounds that are insoluble in water; leaching involves chemical reactions that convert copper into a water-soluble form followed by dissolution. The leaching reagent used by each operation is dependent on the mineralogical composition of the ore material. Several types of reagents are used to produce these chemical reactions, including acids and bacterium (Weiss 1985).

Acid leaching of ores and concentrates is the most common method of hydrometallurgical extraction. Its use is confined to acid-soluble, oxide-type ores that are not associated with acid-consuming rock types containing high concentrations of calcite (such as limestone and dolomite). Some ores require a form of concentration and/or pretreatment, such as roasting or calcification, before leaching. Typical acidic leaching agents include hydrochloric acid (HCL), sulfuric acid ( $H_2SO_4$ ), and iron sulfate ( $Fe_2(SO_4)$ ). Sulfuric and hydrochloric acid leaching at atmospheric pressure is the most common type of copper leaching. Copper minerals such as azurite, malachite, tenorite, and chrysocolla, are completely soluble in sulfuric acid at room temperature. Other, less oxidized, cuprite and sulfide ores, such as chalcocite, bornite, covelite, and chalcopyrite, require the addition of ferric sulfate and oxygen (as oxidants) to accomplish leaching. Leaching ores containing bornite and chalcopyrite with ferric sulfate is very slow, even at elevated temperatures (Weiss 1985).

For certain minerals, alkaline (or basic) leaching is an effective means of extracting copper. Alkaline leaching is more selective than acid leaching and particularly appropriate for ores with large amounts of acid-consuming carbonate rocks. This selectivity often results in lower recovery if the metals are not fully liberated in the comminution stage. Silica- and silicate-rich ores can be treated using alkaline leaching agents at raised temperatures. The principal reagents used in alkaline leaching are the hydroxides and carbonates of sodium and ammonia, but potassium hydroxide, calcium hydroxide, and sodium sulfide also are used. When leaching with ammonia ( $NH_3$ ), ammonium carbonate [ $NH_3/(NH_4)_2CO_3$ ] or ammonium sulfate ( $(NH_3)_2SO_4$ ) systems are often used. Those metals, which can form amines of copper, cobalt, and nickel, can be dissolved in ammoniacal ammonium carbonate or ammoniacal ammonium sulfate solutions at atmospheric pressure. Native copper can be leached in hydrochloric acid or by ammonia/ammoniacal ammonium sulfate agents (Weiss 1985).

Microbial (or bacterial) leaching is appropriate for low-grade sulfide ores at dump, and heap leach, underground or possibly *in situ* leaching operations. This type of leaching is much slower than typical acid or basic leaching. The organism involved in bacterial leaching is called Thiobacillus ferrooxidans, a small rod-shaped cell about 1 micron ( $\mu$ ) in length. It uses atmospheric carbon dioxide ( $CO_2$ ) for cell growth and oxidizes ferrous iron and sulfides to obtain energy for growth. Sulfuric acid is a product of the organism's metabolism. Sufficient dissolved oxygen must be available during these oxidation reactions. The other main growth requirements are ammonia, nitrogen, phosphate, and a suitable temperature (approximately 30°C) and acidity (approximate pH of 2.0). In general, higher or lower temperatures (5°C or 50°C) and higher or lower acidities (pH of 0.5 or 4.5) will not kill the organism, but will severely curtail its activity. Thiobacillus ferrooxidans is usually present in a natural, acidic, sulfide environment. Some metals, such as mercury, silver, and (possibly) molybdenum, can retard or stop leaching by inhibiting or killing the bacteria. Bright sunlight or shallow ponds containing certain other bacteria can also inhibit their activity (Weiss 1985).

The chemical and biochemical reactions involved in microbial leaching of copper ore/minerals are complex. For chalcopyrite, a copper sulfide, it appears that bacteria must come into contact with the mineral to "catalyze" the oxidation reaction. The bacteria first oxidizes the ferrous ore to ferric iron. Ferric iron then chemically oxidizes the sulfide. This bacteria can also assist in the oxidation of sulfur to sulfuric acid. The same reaction also may proceed in the absence of the bacteria, but at a much slower rate. A similar type of reaction occurs for the oxidation of pyrite. These reactions dissolve the sulfide minerals and produce an acidic copper sulfate solution containing ferrous and ferric iron. Other copper

sulfide minerals, such as chalcocite, digenite, bornite, and covellite, are more easily leached than chalcopyrite (Weiss 1985).

In some cases, the amount of copper released during the leaching of low-grade sulfide ores has been found to be directly proportional to the quantity of oxygen reacting with the ore. The rate of oxidation depends on a variety of factors; however, the rate can be maximized by maintaining a relatively low pH; the lower the pH, the faster the rate of oxidation. At pH levels above 2.5 or 2.6, the leaching of copper appears to slow considerably (U.S. EPA 1989e). For an in-depth discussion of the chemical reactions involved in the leaching of the principal copper minerals, refer to EPA 1989e.

Leaching with cyanide has been applied almost exclusively to gold and silver, but cyanide has been applied also to copper for both oxidized and low-grade sulfide ores. The effectiveness of cyanide in leaching depends on the ability of the cyanide ion to form stable complexes with the majority of transition metals. These complexes are strong enough to overcome the relative inertness of gold and silver and the insolubility of copper minerals, such as chalcocite, to form copper-cyanide complexes [ $\text{CuCN}$ ,  $\text{Cu}(\text{CN})_2^-$ ,  $\text{Cu}_2(\text{CN})_3^-$ , and  $\text{Cu}(\text{CM})_3^{2-}$ ] (Weiss 1985).

Figure 1-10 summarizes the hydrometallurgical techniques used for copper recovery. In these techniques, copper values are extracted in aqueous solutions from ore or concentrates. The metal and byproducts are then recovered from the PLS by chemical and electrolytic methods (U.S. Congress, Office of Technology Assessment 1988).



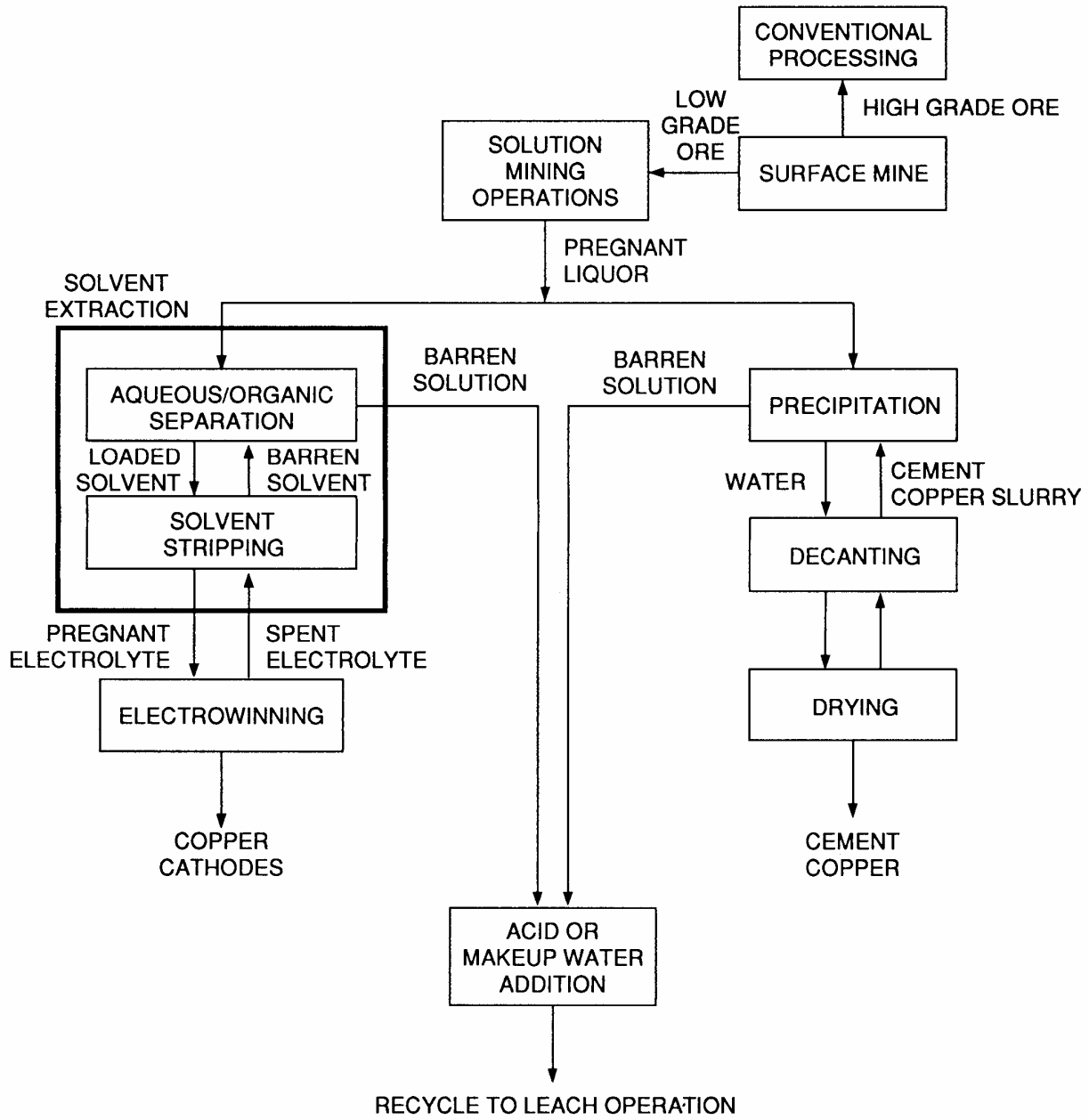
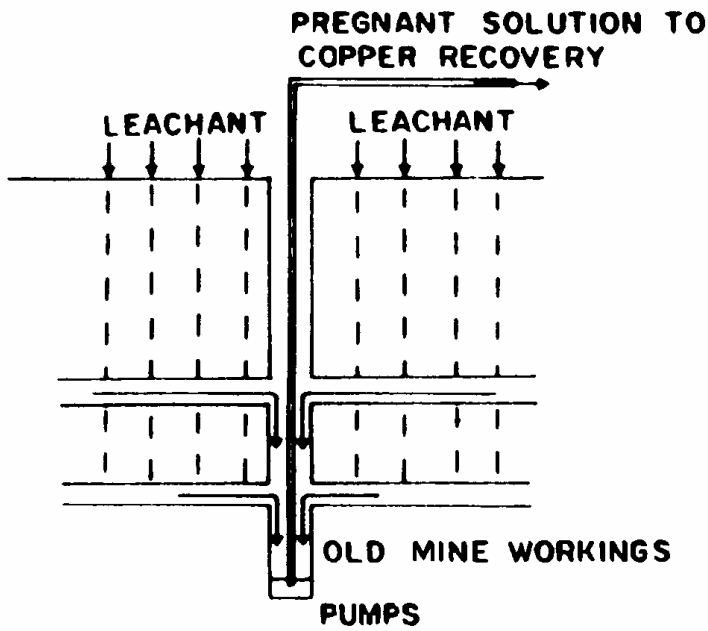

Figure 1-10. Hydrometallurgical Recovery of Copper

(Source: modified from U.S. EPA 1989e)

Another leaching method, involving the leaching of low-grade copper ore without its removal from the ground, is known as *in situ* leaching. *In situ* leaching generally refers to the leaching of either disturbed or undisturbed ore. In either case, *in situ* leaching allows only limited control of the solution compared to a lined heap leach type operation. There are 18 *in situ* copper operations in the United States that leach disturbed ore in existing underground mines. *In situ* leaching has certain advantages over conventional mining and milling, including lower capital investment, lower operating costs, and faster startup times. *In situ* leaching of undisturbed ores is best suited for mining relatively deep-lying oxidized copper deposits. *In situ* leaching of disturbed (rubblized) ore is used for extracting copper from any porous or permeable deposits. *In situ* leaching of undisturbed ore, where the rock has not been moved from its pre-mining position, involves very different mining technologies from deposits that have been fragmented by mining operations (such as backfilled stope, and previous block-caving mining operations) or hydrofractured areas (U.S. EPA 1989e; Biswas and Davenport 1976, Graybeal and Larson, 1989).

*In situ* leaching, as shown in Figures 1-11a and 1-11b, extracts copper from subsurface ore deposits without excavation. Typically, the interstitial porosity and permeability of the rock are important factors in the circulation system. The solutions are injected in wells and recovered by a nearby pump/production-well system. In some cases (where the ore body's interstitial porosity is low), the ore may be prepared for leaching (i.e., broken up) by blasting or hydraulic fracturing. The chemistry of *in situ* leaching is similar to that of heap and dump leaching operations. The ore is oxidized by lixiviant solutions such as mine water, sulfuric acids, or alkalines that are injected from wells into an ore body to leach and remove the valuable minerals. Production wells capture and pump pregnant lixiviant solution from the formation to the leach plant where copper metal is recovered by an SX/EW operation (Biswas and Davenport 1976; U.S. EPA 1984a; U.S. EPA 1989e).



a. *In Situ* Leaching of Old Mine Workings

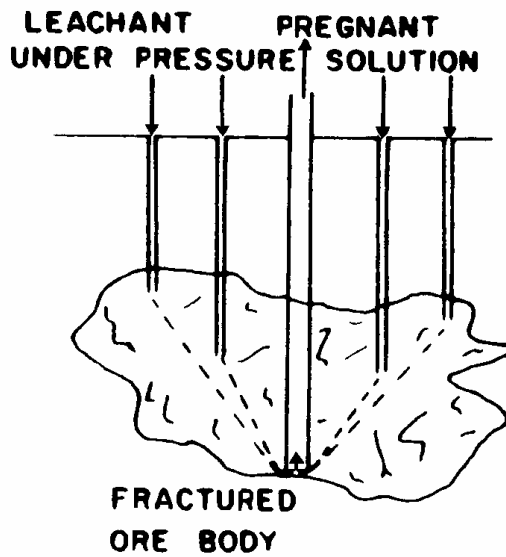

b. *In Situ* Leaching of Fractured Underground Deposit

Figure 1-11. *In Situ* Leaching Operations

(Source: Biswas and Davenport 1976)

Monitoring wells are used to monitor the ground-water system and detect any lixiviant migration beyond the leaching area. After the ore body is depleted, *in situ* leach operators may be required to restore the aquifer. *In situ* mining of undisturbed ore is being conducted on an experimental basis in the copper mining industry (Biswas and Davenport 1976; U.S. EPA 1984a; U.S. EPA 1989e; Graybeal and Larson 1989).

The economics of current mining and recovery methods often prevent the mining of ore that either contains insufficient metal values or requires extensive site preparation or operating expense. For this reason, the *in situ* leach method is gaining favor as a means of recovering additional copper from old mine workings (i.e., block-caved areas and backfilled stopes) from which the primary sulfide deposit has been mined. These types of operations tend to leave behind considerable fractured, copper-bearing rock that is expensive to mine and recover by conventional means (U.S. EPA 1989e).

Stope leaching is a specialized type of *in situ* solution mining that involves leaching of underground, low-grade ore deposits at active and inactive mines. Lixiviant solution is introduced into a worked-out underground mine; backfilled underground stopes; or collapsed block-caved areas (where the stopes were backfilled with low-grade waste rock). As the fluid flows through the stopes or caved areas, it dissolves the minerals and collects in lower levels of the mine (i.e., the sumps); from there it is pumped to the surface. There, the copper is recovered by the SX/EW method (U.S. EPA 1989e). One example of stope leaching occurs at Magma Copper Company's San Manuel facility, where *in situ* leaching, open pit mining, and underground mining are all conducted simultaneously in different parts of the same ore body. During the last few years, all of the production from Cyprus' Casa Grande property has been from *in situ* leaching, including a stope leaching project and testing of *in situ* leaching of virgin ground (U.S. EPA 1989e; Beard 1990).

Most abandoned underground mining operations leave halos or zones of low-grade ore surrounding tunnels, stopes, rises, and pillars. The underground mine development (i.e., the shafts and drifts) required in such mines normally provides the basic circulation needed for a leaching operation.

Usually, lixiviant solutions are introduced into the surrounding low-grade ore zones from above by injection through a series of drillholes. The main shaft is almost always used as a main drainage reservoir. Because drifts are designed to run upgrade, water or leach solutions flow naturally by gravity to the main shaft for recovery. Fluids flowing from the extraction drifts and haulage drifts are usually collected behind a dam placed across the main shaft and pumped to the surface. At block-caved operations, the caving method causes the area above the stope mine to be highly fractured and broken. This expands its volume, which increases the porosity of the low-grade ore. Thus, an ideal circulation system for stope leaching operations is created (U.S. EPA 1989e).

#### Dump Leach Operations (At Open-Pit Mines)

Dump leaching refers to leaching that takes place on an unlined surface. The term "dump leaching" derives from the practice of leaching materials that were initially deposited as waste rock; however, now it also is applied to of run-of-mine, low-grade sulfide or mixed grade sulfide and oxide rock placed on unprepared ground specifically for leaching. Copper dump leaches are typically massive, with waste rock piled into large piles ranging in size from 20 feet to over 100 feet in height. These may cover hundreds of acres and contain millions of tons of waste rock and low-grade ore (Biswas and Davenport 1976). Dump leaching techniques are illustrated in Figure 1-12.

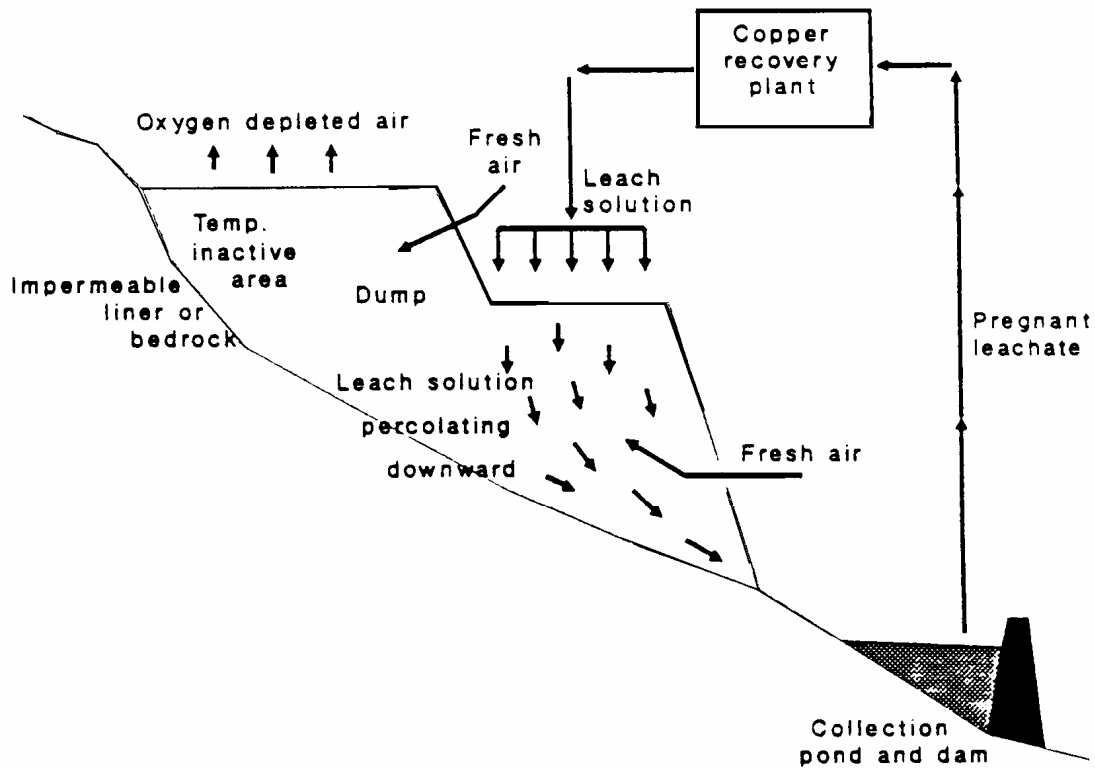
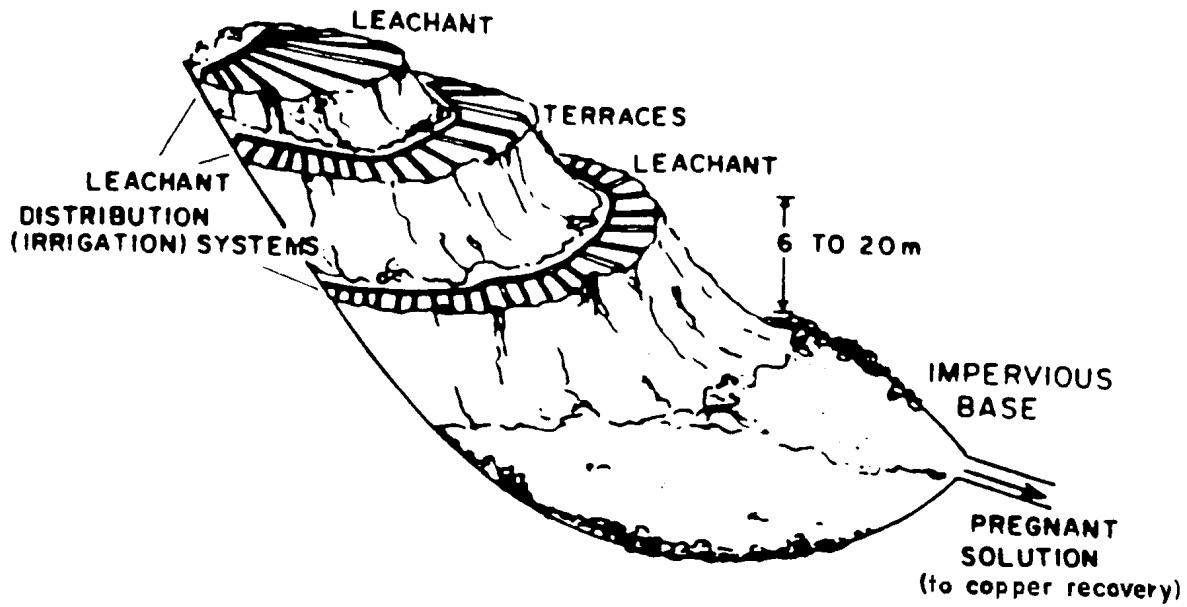

Figure 1-12. Leach Dump Operations

(Source: Biswas and Davenport 1976; U.S. Congress, Office of Technology Assessment 1988)

In the 1920s, large-scale commercial leaching of waste piles was initiated to recover copper. These operations entailed the addition of low pH solution to the piles to accelerate leaching, the collection of PLS, and the extraction of copper by iron precipitation to generate "cement copper." The sites for these historic dump leaches were selected primarily to minimize haulage distances, thereby reducing costs (the extent of cost savings would have been based on site specific factors). Dump leaches were located and designed to prevent the loss of leach solution (U.S. EPA 1989e).

Waste rock, removed to expose the ore body, was placed in piles close to the pit site. Water seepage from the piles was found to contain high concentrations of copper. Miners realized the opportunity to recover copper at virtually no cost. The percentage of copper produced from leaching operations has increased in recent years due to the low operating costs of dump leaching relative to conventional milling operations (the extent of cost savings is based on site-specific factors). Dump leaching is usually associated with copper recovery, although uranium and gold may be leached through a similar procedure. Dumps are usually sited in an area where the slope of the native terrain provides the means for collection of pregnant liquor. The leach solution flows by gravity through the dump and then over the slope of the native ground beneath the dump to a collection point, usually a pond, at the downgrade toe of the dump (U.S. EPA 1989e).

The materials employed generally vary considerably in particle size, from large angular blocks of hard rock to highly weathered fine-grained soils. Most of the material is less than 0.6 meter in diameter. In most dump leach operations, the material is hauled to the top of the dump by trucks. Bulldozers are used to level the surfaces and edges of the dump. The material is typically deposited by end-dumping in lifts on top of an existing dump that has already been leached. Large dumps are usually raised in lifts of 15 to 30 meters. Some sorting of materials occurs when this method of deposition is used. Coarser fragments tend to roll down to the bottom of the slope, whereas finer materials accumulate near the surface of the dump. A degree of compacting in the top meter of each lift results from the heavy equipment and truck use. After the lift is completed, the top layer is scarified (by a bulldozer and a ripper) to facilitate infiltration of the leach solution (U.S. EPA 1989e).

Most dump leaches begin to settle as they are built and continue to settle after the leach solutions have been applied. This continued settling results, in part, from the percolating liquid moving the finer particles into the spaces between larger particles. The dump is compressed also by the added weight of the solutions and the destruction of the bridging rocks' competency by chemical reactions that depreciate the rock (U.S. EPA 1989e).

Natural precipitation, mine water, raffinate, makeup water, or dilute sulfuric acid may be used as leach solution (i.e., lixiviant). As the lixiviant infiltrates the pile and leaches out copper minerals by oxidizing the pyrite to form sulfuric acid and ferrous iron solution, the sulfuric acid solution reacts with the ore minerals to ionize the copper into solution. Once dissolved, the metals remain in solution. This leaching method is best suited to nonsulfide oxide ores rich in azurite, malachite, and other oxide minerals. Sulfide ores rich in chalcocite may also be leached using a similar method. In this method, the ore is leached by an active bacterial population that uses oxygen to convert ferrous iron to ferric iron, which reacts with chalcocite-liberating copper and generates ferric sulfide (U.S. EPA 1984a).

Several methods may be used to distribute leach solutions over the dumps, including natural precipitation, sprinkler systems that spray the leach solution over the piles, flooding of infiltration ditches or construction of leach solution ponds on top of the dumps, distribution of leach solution through perforated pipe on top of the dump (known as trickle systems), and the injection of leach solutions through drill holes into the dump. The leach solution percolates through the dump and PLS is collected in ditches or sumps at the toe of the dump. These ditches and sumps are lined at some sites, and are

unlined at others. PLS is then treated by solvent extraction or cementation. Metals associated with the copper ores that dissolve (and are potential contaminants) include arsenic, cadmium, chromium, and selenium (U.S. EPA 1985a; U.S. EPA 1984a).

### Heap Leaching

In contrast to dump leaching (described in the previous section), heap leaching refers to the leaching of low-grade ore that has been deposited on a specially prepared, lined pad constructed using synthetic material, asphalt, or compacted clay. In heap leaching, the ore is frequently beneficiated by some type of size reduction (usually crushing) prior to placement on the pad. Site-specific characteristics determine the nature and extent of the crushing and the leaching operations used (U.S. EPA 1989e).

Heap leach pads are constructed above one or more layers of impermeable liner material. Liners can be constructed using synthetic membrane [such as High-Density Polyethylene (HDPE)] and/or natural material (such as compacted native soils or clays or unfractured/unfaulted bedrock). Most leach sites are selected to take advantage of existing, less permeable surfaces and to utilize the natural slope of ridges and valleys for the collection of PLS. Land with this type of geology and terrain, however, is not always within a reasonable hauling distance of the mining operation.

A typical heap leach operation is depicted in Figure 1-13. The same basic principles and procedures discussed earlier with regard to dump leaching operations apply to heap leach operations. Heap leach operations, as opposed to dump leach operations, have the following characteristics: (1) higher lixiviant concentrations generally are used; (2) leach piles may be neutralized after leaching operations are completed; (3) the leach pad design is substantially different (i.e., the size is smaller); (4) the ore is finer grained (i.e., usually less than 10 cm); (5) the leaching is considerably faster; and (6) the extraction of oxide copper is greater. The copper recovery of sulfide minerals in the heaps, as with dumps, is usually low due to shorter leaching times (100 to 180 days) and relatively poor lixiviant-sulfide dissolution kinetics (Biswas and Davenport 1976; U.S. EPA 1989e).

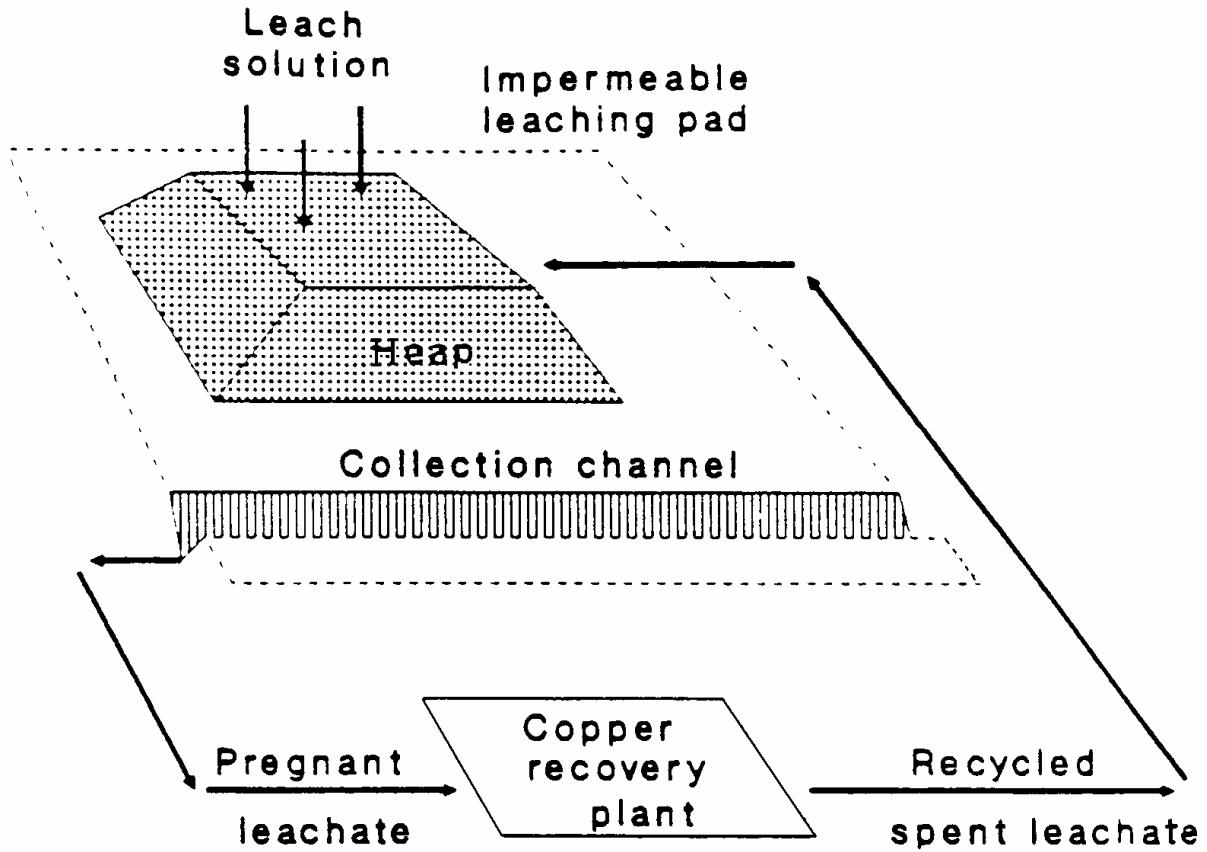

Figure 1-13.Heap Leach Unit Design

(Source: U.S. Congress, Office of Technology Assessment 1988)

Heap leaching is generally suited to oxide ores for several reasons: usually oxide deposits are smaller



than sulfide deposits; oxides leach more rapidly than sulfides; the oxide leachate has a higher copper content than the sulfide leachate; and high-grade refractory oxide ores are not recoverable in the standard sulfide flotation concentrator (U.S. EPA 1989e). Copper heap leach operations are much smaller than copper dump leaches. On the average, heaps contain between 100,000 and 500,000 metric tons of ore. Copper heaps are designed and operated to minimize truck traffic and bull-dozer work on the surface. This serves to reduce the compaction resulting from these activities, thereby improving the permeability of the heap. One method of constructing a new heap involves placement of the leach material in a strip along the center of the new heap. Subsequent loads are then dumped along the outer edge of the strip and pushed over the side with a bulldozer to build the heap to its full width. With this method of material emplacement, only the top meter of the heap becomes compacted. This layer is subsequently scarified to promote infiltration of the leach solution. The heap leaching cycle typically lasts between 60 and 180 days. Application of leaching solution is generally stopped after a specified period, which is dictated by the leaching cycle or when the copper content of the pregnant liquor falls below a predetermined concentration. Subsequently, the surface of the nearly barren area is scarified by ripping and another lift is begun on the surface (U.S. EPA 1989e).

Because most distribution methods do not provide completely uniform coverage, the rate at which the solution is applied to the heap will vary. The application rate is generally defined as the volumetric flow rate of the leach solution divided by the surface area to which the solution is actually being applied. The average application rate varies between 20 liters per square meter ( $l/m^2$ ) per hour for sprinklers, to as much as 200  $l/m^2$  per hour for pond leaching (U.S. EPA 1989e).

In practice, most heaps are leached in sections. Near the end of the leach cycle, heap permeability diminishes because of the accumulation of decomposed clay materials and iron salt precipitates. This requires that the surface be scarified by ripping, after which leaching is resumed or another lift is begun on the surface. The alternate wetting and resting during the leach cycle promotes efficient leaching of sulfide minerals within the heap (U.S. EPA 1989e).

Under the influence of gravity, the leaching solution percolates down through the ore and carries the dissolved copper along with it. Uniform distribution of the leach solution throughout the heap is difficult to achieve. In sloped areas, channeling the solution down the slope accelerates runoff. Within the heap, alternate layers of coarse and fine materials (as a result of poor heap construction) promote horizontal solution flow, which may result in the discharge of the copper-bearing liquor from the sides of the heap rather than from the base. The total volume of leach solutions added to the heap must be controlled to prevent sloped areas from becoming saturated. Excess moisture in the pile can lead to slumping of large amounts of material (U.S. EPA 1989e).

When PLS reaches the bottom of the heap, it flows to a collection channel and/or holding pond at the toe of the dump. Holding ponds generally are located in natural drainage basins enclosed by a dam or excavated and bermed on level surfaces. The pregnant solution is pumped from the dam to the precipitation or solvent extraction plant, where the copper is recovered from solution (U.S. EPA 1989e).

#### Vat Leaching

The vat leaching process works on the same principles as the dump and heap leaching operations described above, except that it is a high-production-rate method conducted in a system of vats or tanks using concentrated lixiviant solutions. Vat leaching typically is used to extract copper from oxide ores by exposing the crushed ore to concentrated sulfuric acid (lixiviant) in a series of large tanks or vats. The vats are usually designed in a series configuration, which acts to concentrate the copper content of the solutions as a function of ore-lixiviant contact time (U.S. EPA 1989e).

Vat leach units may be large drums, barrels, tanks, or vats. The design capacity of the leaching units is dependent on the amount of ore to be leached. For example, a 25-meter-long, 15-meter-wide, and 6-meter-deep vat unit is capable of leaching between 3,000 and 5,000 tons of ore per cycle. Leaching operations may be conducted under a number of environments, including slightly subatmospheric, atmospheric, or superatmospheric pressures, and under ambient or elevated temperatures (Weiss 1985).

Vat leaching units can be constructed of a number of materials, depending on the composition of the slurried ore feed, the lixiviant used, and the conditions under which leaching will take place. Table 1-6 gives examples of some vat construction materials recommended for use with different lixivants.

**Table 1-6.Lixivants and Recommended Construction Materials**

<b>Lixiviant</b>	<b>Recommended Construction Materials</b>
Sulfuric Acid	Wood, lead, lead and acid brick, stainless steel, titanium, and HDPE
Hydrochloric Acid	Rubber-lined mild steel, rubber lining and acid brick (for a temperature of 70°C), and glass
Sodium Hydroxide	Mild steel
Ammonium Hydroxide	Stainless steel

(Source: Weiss 1985)

Vat and agitation (tank) leaching are usually performed on relatively higher oxidized ores. Tank methods tend to recover copper more rapidly using shorter leach cycle times than heap or dump leaching operations. Generally, copper recovery is higher, copper content in the leach solution is higher, and solution losses are lower with tank methods (U.S. EPA 1984a). Vat leaching has been preferred over heap leaching in cases where high-grade ore requires crushing to permit adequate contact between the leach solution and the copper minerals. The advantages of this method are high copper extraction rates and recoveries, short leach cycles, and negligible solution losses (U.S. EPA 1989e). The disadvantages are the low tonnages beneficiated, high suspended solids concentrations in PLS that cause problems in the SX/EW plant, and high operating costs.

In the tank leaching process, the ore is first crushed to approximately less than 1 cm. The ore is screened to separate the fines before it is placed in the vats. Most vat leaching operations use several large, rectangular tanks with floors that act as filters to facilitate the upflow and downflow of solutions. A typical vat measures 25 meters long, 15 meters wide, and 6 meters deep and contains between 3,000 and 5,000 metric tons of material. Vat leaching is a batch operation; its cycle involves vat loading; ore leaching, washing, and draining; and vat excavating. The crushed ore is immersed in 50 to 100 kilograms per cubic meter (kg/m<sup>3</sup>) of sulfuric acid solution. The leaching usually takes place in a sequence of four to seven soak-drain cycles. The pregnant solutions from the first two or three soaks are used as electrolyte (after purification), while the remaining solutions (which are more dilute) are reused to leach subsequent fresh batches of ore. The solutions from the remaining soaks are recycled as leachate for subsequent batches of fresh ore (Biswas and Davenport 1976; U.S. EPA 1989e).

Continuous vat leaching, in which leachate flows continuously through ore in a sequence of vats, is now being practiced at several mines. Factors that affect the leach rate (in both batch and continuous leaching) include particle size and porosity, temperature, and acid strength. The overall cycle may take

from 10 to 14 days. Vat leaching produces a PLS of sufficient copper concentration for electrowinning (30 to 50 kg/m<sup>3</sup> of copper). If the iron content of the solution is high, the PLS may be sent for solvent extraction prior to electrowinning. This is necessary because iron may reduce the efficiency of the electrowinning (this method is discussed in more detail later in this report) (Biswas and Davenport 1976; U.S. EPA 1989e).

Agitated vat leaching refers to the relatively rapid leaching of fine particles of copper oxide ore or roaster calcines with a strong sulfuric acid solution in agitated tanks. The tanks are stirred or agitated by mechanical devices or piped steam discharge. Compressed air is used in a similar method of agitation in a pressurized tank operation. A pressurized operation is used in several different types of autoclaves. Figure 1-14 illustrates two examples of pressurized vat leach systems (U.S. EPA 1989e).

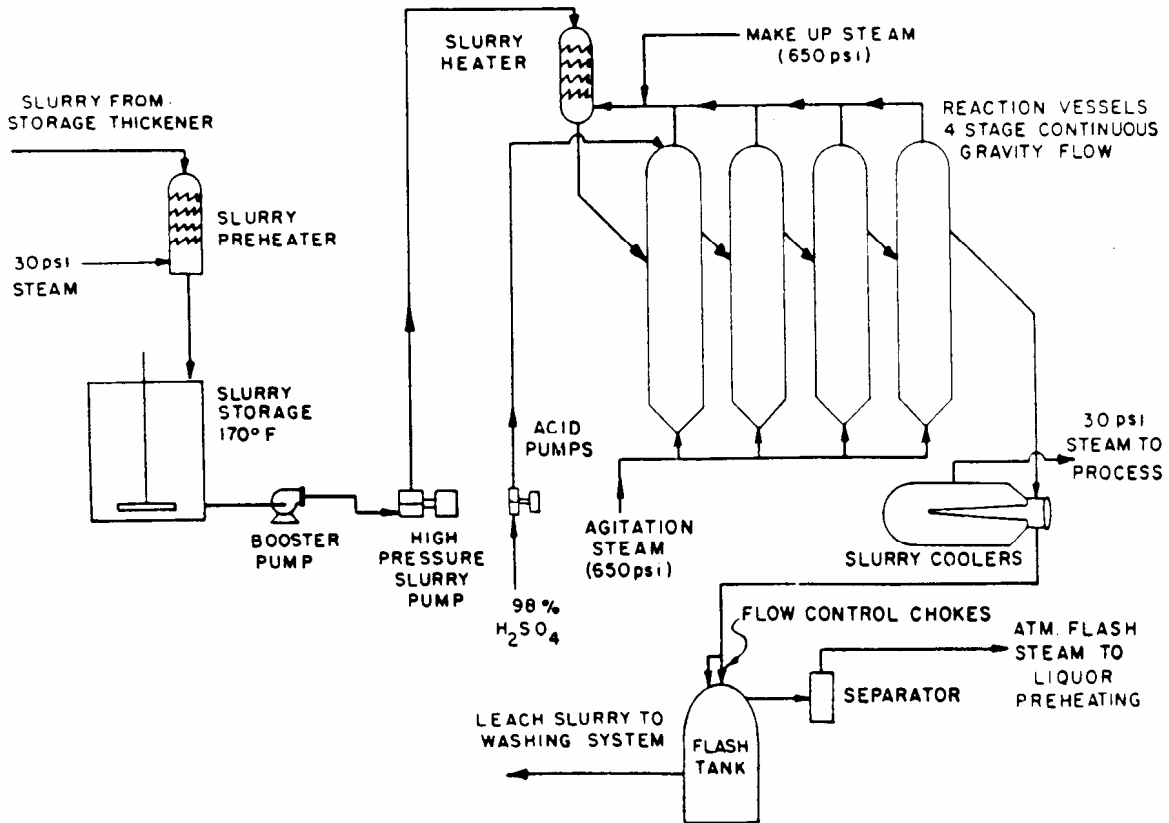
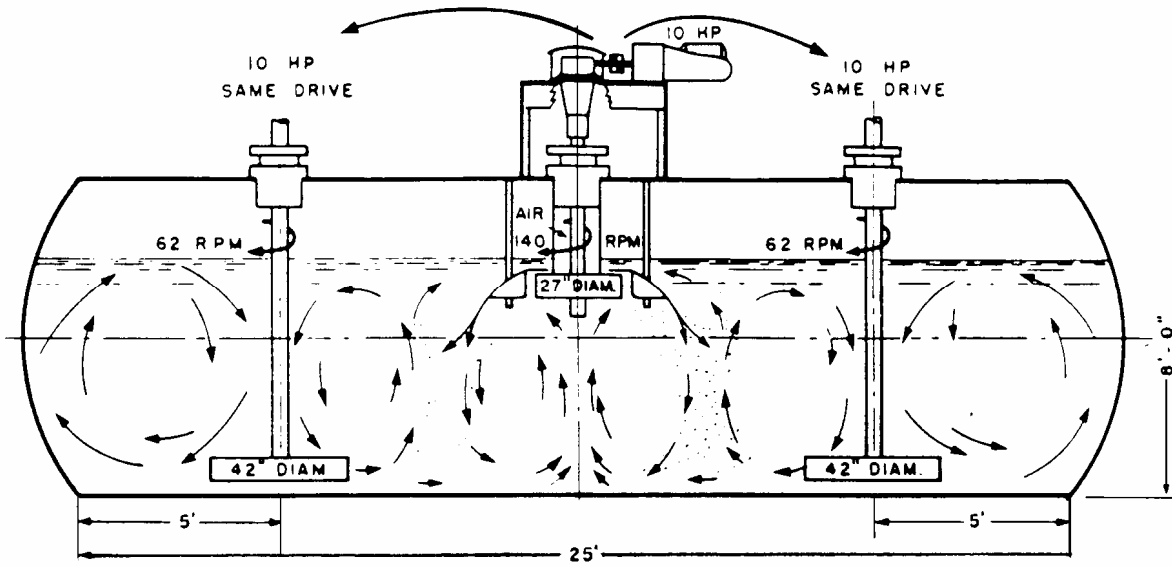

Figure 1-14. Typical Autoclave and Vat Leaching Circuit

(Source: Weiss 1985)

This leaching method has been used primarily in conjunction with vat leaching operations to recover copper from the fines filtered out of the vat material. Additional lean material is crushed and ground to a

fine-sized particle [90 percent are less than 75 micrometers ( $\mu\text{m}$ )] and combined with the fines from the vat operation. This material is then mixed with the leach solution to form a slurry with a solids content of between 30 and 40 percent. The mixture is agitated by air or mechanical means in a series of three or six tanks [with a volume of 50 to 200 cubic meters ( $\text{m}^3$ )] for a period of two to five hours. On completion of the leach cycle, the pregnant liquor is separated from the acid-insoluble residue by concurrent or countercurrent washing. Because of the fine particle size of the solids, the strength of the acid solution, and the agitation of the leach slurry (which promotes better liquid-solid contact), agitation leaching demonstrates the highest recovery of copper. In some instances, recovery is greater than 95 percent. Vat and agitation leaching are generally more rapid, more efficient, and much more costly than dump or heap leaching (U.S. EPA 1989e).

### Cementation

In the past, copper was recovered from leach solutions through a cementation technique (precipitation from solution by the replacement of copper in solution by metallic iron). This has been a source of relatively inexpensive copper; however, the cement copper produced is relatively impure compared to electrowon copper and must be smelted and refined along with flotation concentrates (Beard 1990).

In the cementation technique, PLS flows to a precipitator pond filled with scrap iron or steel. The copper chemically reacts with, and precipitates onto the steel surfaces. The iron is dissolved into solution, and the copper precipitates out (i.e., replaces) the iron. The cemented copper later detaches from the steel surfaces as flakes or powder when it is washed with high-pressure streams of water. Although subsequent treatment by a normal smelting/refining method is required, copper recovery from the pregnant solution is very high. Typically, cemented copper contains between 65 and 85 percent pure copper, with oxides of iron and other traces of silica and aluminum oxides (Beard 1990).

Swapping ions occurs whenever a metal ion in solution is reduced to an elemental state by a more reactive metal. Iron is more reactive than gold, mercury, silver, or copper; hence these metals easily precipitate. Iron is only slightly more reactive than lead, tin, nickel, or cadmium; and these metals do not easily precipitate since kinetics control the reaction. Chromium, zinc, aluminum, magnesium, calcium, and sodium are more reactive than iron and also do not precipitate. As a result, barren leach solutions remain very acidic and contain elevated levels of metals and salts that are more reactive than iron or are similarly reactive (U.S. EPA 1987).

There are numerous cementation precipitator designs and configurations. Typically, precipitators are shallow-round or stair-stepped wooden or concrete basins (U.S. Congress, Office of Technology Assessment 1988). The simplest and most common precipitation system used in the copper mining industry is an open-laundry-type cementation system. PLS flows down a wooden or concrete trough or series of troughs filled with scrap iron. Launderers vary in size and dimension depending on the amounts of leach liquor being treated; the launder may be straight or zigzagged. More modern units employ a series of wooden grids, positioned above the bottom of the launderers. These permit the cemented copper to fall to the bottom, where it easily can be recovered (Biswas and Davenport 1976).

Several compact and dynamic cementation systems have been developed and are used industrially. The most successful is the Kennecott Cone System Precipitator, in which the PLS is forced upwards in a swirling motion through shredded steel scrap. The discussion of Bingham Canyon mine in Appendix 1-B presents a complete description of the Kennecott Cone System Precipitator. The Kennecott Cone System Precipitator has proven to be highly effective and has been used by many large-scale leaching operations. In this system, fine, undissolved solid particles (called pulp) are concentrated with the copper cemented particles. Consequently, the cement concentrates containing the pulp must be further beneficiated by

flotation. The cemented copper is easily floated with xanthate or dixanthogen collectors (Biswas and Davenport 1976).

### Ion Exchange

The use of ion-exchange recovery in the copper industry is not widespread. Generally, three circuits are used in an ion-recovery operation: the extraction circuit, the elution circuit, and the precipitation circuit. The system is designed to recycle lixiviant back to the leach operation. (U.S. Congress, Office of Technology Assessment 1988; Arizona BADCT Draft; Utah Department of Health, undated).

The extraction circuit extracts metals from the pregnant lixiviant. Copper complexes with the resin as the pregnant lixiviant flows through the resin in the ion exchange unit. Barren lixiviant leaving the ion exchange unit is refortified with chemicals and recycled. The copper metal is released from the loaded resin in the elution circuit. This is accomplished using a high-ionic-strength solution. The effluent is known as the pregnant eluate. The pregnant eluate proceeds to the precipitation circuit, where acid is added to destroy the copper complexes in solution and precipitate copper oxide. The barren electrolyte is reprocessed to the elution circuit, although electrolyte is constantly bled from the system to control the level of impurities (U.S. Congress, Office of Technology Assessment 1988; Arizona BADCT Draft; State of Utah, undated).

### Solvent Extraction

The first SX/EW plant was developed during the 1960s at the Bluebird property near Miami, Arizona. Solvent extraction largely had been confined to copper oxides until recent developments in leaching methods. Figure 1-15 provides a flow diagram for a typical SX/EW plant. In the traditional solvent extraction circuit, copper is dissolved from the ore into an aqueous solution by weak sulfuric acid. The pregnant solution is then pumped to a solvent extraction plant, where it is mixed with an organic solvent (U.S. Congress, Office of Technology Assessment 1988; Arizona BADCT Draft; State of Utah, undated).

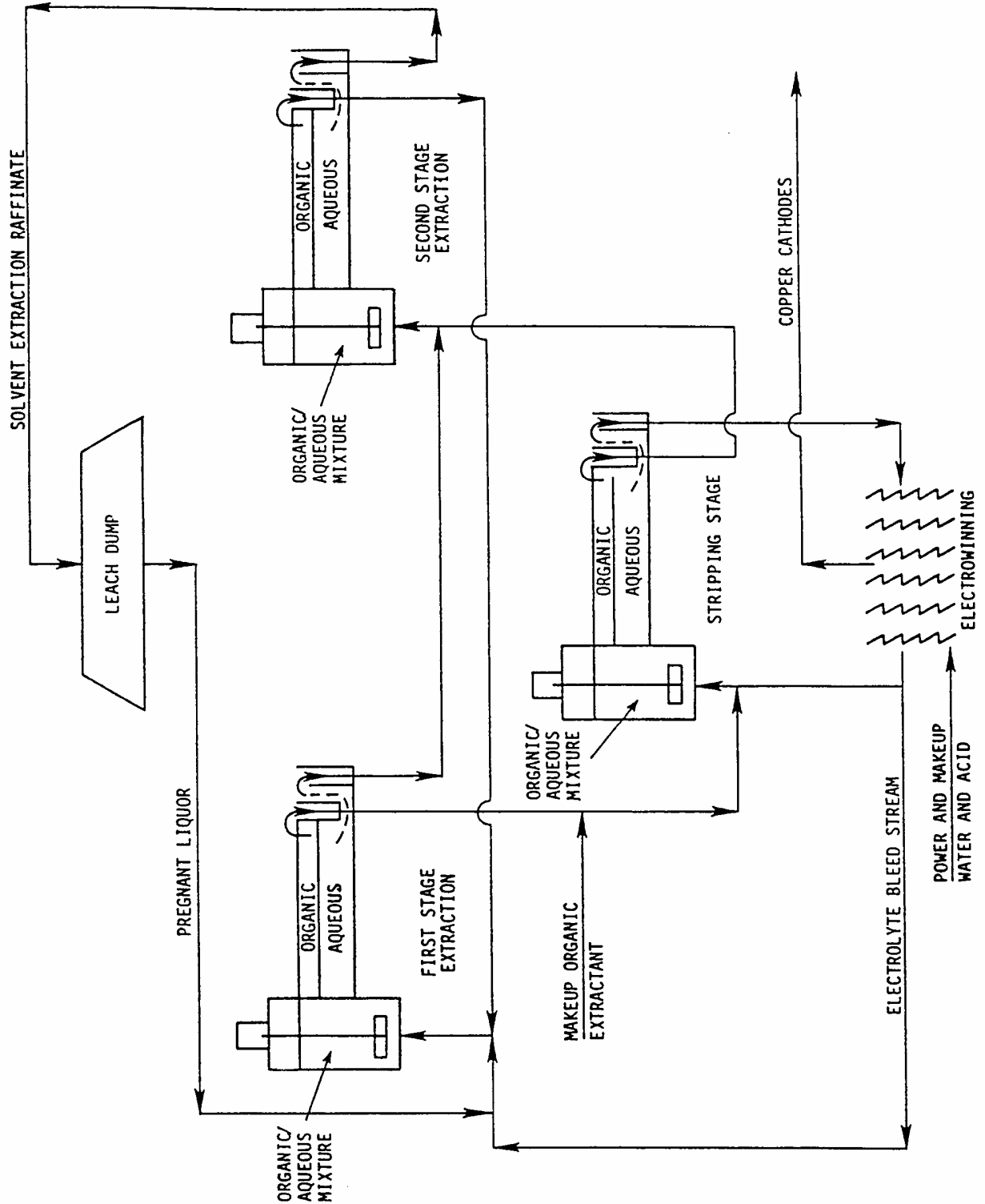

Figure 1-15. Typical Solvent Extraction/Electrowinning (SX/EW) Plant

(Source: U.S. EPA 1989e)

The solvent extraction operation is a two-stage method. In the first stage, low-grade, impure leach solutions containing copper, iron, and other base-metal ions are fed to the extraction stage mixer-settler.

In the mixer, the aqueous solution is contacted with an active organic extractant (chelating agent) in an organic diluent (usually kerosene), forming a copper-organic complex. The organic phase extractant is designed to extract only the desired metal ion (i.e., copper), while impurities such as iron or molybdenum are left behind in the aqueous phase. The aqueous-organic dispersion is physically separated in a settler stage (U.S. Congress, Office of Technology Assessment 1988; Arizona BADCT Draft; U.S. EPA 1984a; Engineering and Mining Journal 1990).

Because of the development of the faster, more selective salicylaldoxime reagents, most of the new copper solvent extraction plants can use two-stage extraction with a single stripping stage in each circuit. Two stages of extraction have proven sufficient to remove 90 percent or more of the copper from leach solutions, whereas early plant designs required three or four stages of extraction (Engineering and Mining Journal 1990).

The barren aqueous solution, called raffinate, is recirculated back to the leaching units. The loaded organic solution is transferred from the extraction section to the stripping section. The major advantage of solvent extraction is that the electrolyte solution it produces is almost free of impurities (U.S. Congress, Office of Technology Assessment 1988; Arizona BADCT Draft; Engineering and Mining Journal 1990).

In the second stage, the loaded organic solution is stripped with concentrated sulfuric acid solution (spent tankhouse electrolyte) to produce a clean, high-grade solution of copper for electrowinning. The stripping section can have one or more mixer-settler stages. In particular, the loaded-organic phase is mixed with a highly acidic electrolyte (returned from electrowinning), which strips the copper ions from the organic phase. Then the mixture is allowed to separate in settling tanks, where the barren organic solution can be recycled to the extraction stage. The copper-enriched, strong electrolyte flows from the stripping stages to the strong-electrolyte tanks, where it is pumped to the electrolyte filters for removal of the entrained organics or solids. The clarified, strong electrolyte (which is the concentrated sulfuric acid from the solvent extraction operation) flows to electrolyte circulation tanks, where it becomes electrolyte for the electrowinning tankhouse. At the tankhouse, copper is plated out of solution onto cathodes (U.S. Congress, Office of Technology Assessment 1988; Arizona BADCT Draft; U.S. EPA 1984a; Engineering and Mining Journal 1990).

The solvent extraction method is dependent on the solubility of the reagents and the equilibrium constants that control the reactions. The higher the equilibrium constant, the more effective the reagent is in stripping copper from the pregnant solution. Specifically, two factors that are controlled by the equilibrium constant and that significantly impact the effectiveness of a reagent are the rate of the reaction and the range between loading and stripping for a particular reagent (U.S. Congress, Office of Technology Assessment 1988; Arizona BADCT Draft; U.S. EPA 1984a; Engineering and Mining Journal 1990).

The most prominent copper extractants used in the copper plant solvent extraction system are LIX and Acorga. These reagents are referred to by their individual trade names because their exact chemical compositions are listed as confidential business information (although some general information is available).

The most widely used LIX reagents are LIX 63, 64N, 622, 84, 860, and 984. The most widely used Acorga reagents are PT-5050, P-5100, M-5640, and M-5615. They are usually composed of either aldoxime or ketoxime compounds in an organic solvent of kerosene.

Modifiers are usually added to improve the reaction rates and/or phase separation. Data are very limited



on the various types of modifiers used at copper extraction plants, although several were identified: LIX 6022 is a tridecanol-modified dodecyl-salicylaldoxime; PT-5050 is a tridecanol-modified nonyl-salicylaldoxime; LIX 860 is an unmodified dececylsalicylaldoxime; LIX 84 is an unmodified nonylacetophenone; and LIX 984 is 50-50 mixture of LIX 860 and LIX84.

The obvious advantage of solvent extraction is that cathode copper of salable quality can be produced directly from leach solutions. Therefore, smelting is not required. Interest in the SX/EW method has grown gradually. Twelve plants were in operation during 1989. Several expansions and new plants are being planned, while the cementation process is being phased out (except as a subsidiary method of copper production) (Beard 1990).

### Electrowinning

Electrowinning is the method used to recover copper from the electrolyte solution produced by solvent extraction. Electrowinning uses inert (nondissolving) anodes made of lead (alloyed with calcium and tin) or stainless steel, referred to as sheets. (U.S. Congress, Office of Technology Assessment 1988).

To stabilize the tankhouse operating temperature and preheat the incoming electrolyte solution, strong electrolyte (after filtration) is passed through heat exchangers where heat is extracted from outgoing, warmer, spent electrolyte. After passing through starting-sheet cells, the strong electrolyte is received in a circulation tank. In the circulation tank, the strong electrolyte is mixed with spent electrolyte returning from the electrowinning cells. Water and any deposit-modifying reagents are added in this tank. The feed electrolyte is then pumped to the electrolytic cells continuously. The electrochemical reaction at the lead-based anodes produces oxygen gas and sulfuric acid by electrolysis. Copper is plated on cathodes of stainless steel or on thin-copper starting sheets. The cathode copper is then shipped to a rod mill for fabrication. The spent acid is recycled and pumped back to the leaching operation, while some of the electrolyte is pumped to the solvent extraction strip-mixer-settlers via the electrolyte heat exchangers (U.S. Congress, Office of Technology Assessment 1988; Engineering and Mining Journal 1990).

If the cathode copper is plated onto a stainless steel "blank," the copper plate is peeled off the blank prior to shipment and the blank is reused. This blank and the techniques developed to optimize its use are known as the "ISA" method. Magma Copper Co. has extended the use of this technology, which was first used in electroplating, to electrowinning operations (Engineering and Mining Journal 1990).

The ISA method uses conventional, insoluble anodes, but rather than using starting sheets to receive the cathode deposit, the ISA method employs 316L stainless steel blanks. About 7 days are required to complete a cathode side, and automated equipment is used to strip them (Engineering and Mining Journal 1990). This total production stripping system has numerous benefits, including the following:

- There is no starting-sheet deposition.
- There is no stripping labor, stripping, or sheet-fabrication equipment.
- The better-defined cathode (in the form of a rigid blank) is less prone to warping, and therefore, requires less rigid inspection.
- Shorter cathode cycles reduce the metal inventory.
- There are no suspension loops to corrode. Therefore, the incidence of cell-liner cutting is lower and crane handling is easier.

The elimination of sheet production and reduced inspection means the work force is up to 60 percent smaller than it is at a conventional plant (Engineering and Mining Journal 1990)